

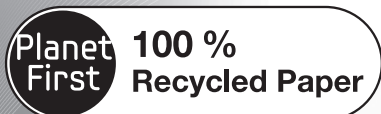

Microwave Oven

Owner's Instructions & Cooking Guide

Please be advised that the Samsung warranty does NOT cover service calls to explain product operation, correct improper installation, or perform normal cleaning or maintenance.



This manual is made with 100 % recycled paper.

GE83KR*-1 GE83KR*-1* GE83*KR*-1
GE83KR*-2 GE83KR*-2* GE83*KR*-2
GE83KR*-3 GE83KR*-3* GE83*KR*-3
GE83MR** GE83AR*

imagine the possibilities

Thank you for purchasing this Samsung product.



contents

Safety information	2
Quick look-up guide	11
Oven features	12
Oven (GE83*KR*-1, GE83*KR*-2, GE83*KR*-3, GE83KR*-1, GE83KR*-2, GE83KR*-3, GE83KR*-1*, GE83KR*-2*, GE83KR*-3*)	12
Oven (GE83MR**)	13
Oven (GE83AR*)	13
Control panel (GE83*KR*-1, GE83*KR*-2, GE83*KR*-3, GE83KR*-1, GE83KR*-2, GE83KR*-3, GE83KR*-1*, GE83KR*-2*, GE83KR*-3*)	14
Control panel (GE83MR**)	14
Control panel (GE83AR*)	15
Accessories	15
Oven use	16
How a microwave oven works	16
Checking that your oven is operating correctly	16
Setting the time	17
Cooking/Reheating	17
Power levels	18
Adjusting the cooking time	18
Stopping the cooking	18
Setting the energy save mode	18
Using the auto russian cook feature	19
Auto russian cook feature/cook	19
Using the auto rapid defrost feature	25
Auto rapid defrost settings	26
Grilling	26
Combining microwaves and the grill	27
Choosing the accessories	27
Switching the beeper off	27
Safety-locking your microwave oven	28
Power steam cooking guide (only GE83KR*-X models)	28
Cookware guide	30
Cooking guide	31
Troubleshooting and error code	38
Troubleshooting	38
Error code	39
Technical specifications	39









safety information

USING THIS INSTRUCTION BOOKLET

You have just purchased a SAMSUNG microwave oven. Your Owner's Instructions contain valuable information on cooking with your microwave oven:

- Safety precautions
- Suitable accessories and cookware
- Useful cooking tips
- Cooking tips

LEGEND FOR SYMBOLS AND ICONS

	WARNING	Hazards or unsafe practices that may result in severe personal injury or death .	
	CAUTION	Hazards or unsafe practices that may result in minor personal injury or property damage .	
	Warning; Fire hazard		Warning; Hot surface
	Warning; Electricity		Warning; Explosive material
	Do NOT attempt.		Do NOT touch.
	Do NOT disassemble.		Follow directions explicitly.
	Unplug the power plug from the wall socket.		Make sure the machine is grounded to prevent electric shock.
	Call the service center for help.		Note
	Important		

IMPORTANT SAFETY INSTRUCTIONS READ CAREFULLY AND KEEP FOR FUTURE REFERENCE.

Make sure that these safety precautions are obeyed at all times.

Before using the oven, confirm that the following instructions are followed.

WARNING

(Microwave function only)

- WARNING:** If the door or door seals are damaged, the oven must not be operated until it has been repaired by a competent person.
- WARNING:** It is hazardous for anyone other than a competent person to carry out any service or repair operation that involves the removal of a cover which gives protection against exposure to microwave energy.
- This appliance is intended to be used in household only.

 **WARNING:** Only allow children to use the oven without supervision when adequate instructions have been given so that the child is able to use the oven in a safe way and understands the hazards of improper use.

 **WARNING:** This appliance can be used by children aged from 8 years and above and persons with reduced physical, sensory or mental capabilities or lack of experience and knowledge if they have been given supervision or instruction concerning use of the appliance in a safe way and understand the hazards involved. Children shall not play with the appliance. Cleaning and user maintenance shall not be made by children unless they are aged from 8 years and above and supervised.

 Only use utensils that are suitable for use in microwave ovens.

 When heating food in plastic or paper containers, keep an eye on the oven due to the possibility of ignitions.

★	The microwave oven is intended for heating food and beverages. Drying of food or clothing and heating of warming pads, slippers, sponges, damp cloth and similar may lead to risk of injury, ignition or fire.
☞	If smoke is emitted, switch off or unplug the appliance and keep the door closed in order to stifle any flames.
★	WARNING: Microwave heating of beverages can result in delayed eruptive boiling, therefore care must be taken when handling the container.
★	WARNING: The contents of feeding bottles and baby food jars shall be stirred or shaken and the temperature checked before consumption, in order to avoid burns.
☒	Eggs in their shell and whole hard-boiled eggs should not be heated in microwave ovens since they may explode, even after microwave heating has ended.
★	The oven should be cleaned regularly and any food deposits removed.

☞	Failure to maintain the oven in a clean condition could lead to deterioration of the surface that could adversely affect the life of the appliance and possibly result in a hazardous situation.
☒	The appliance is not intended for installing in road vehicles, caravans and similar vehicles etc.
★	This appliance is not intended for use by persons (including children) with reduced physical, sensory or mental capabilities, or lack of experience and knowledge, unless they have been given supervision or instruction concerning use of the appliance by a person responsible for their safety.
★	Children should be supervised to ensure that they do not play with the appliance.
☞	If the supply cord is damaged, it must be replaced by the manufacturer, its service agent or similarly qualified persons in order to avoid a hazard.
☒	WARNING: Liquids and other foods must not be heated in sealed containers since they are liable to explode;

<input type="checkbox"/>	The appliance should not be cleaned with a water jet.
<input checked="" type="checkbox"/>	This oven should be positioned proper direction and height permitting easy access to cavity and control area.
<input checked="" type="checkbox"/>	Before using the your oven first time, oven should be operated with the water during 10 minute and then used.
<input checked="" type="checkbox"/>	If the oven generates a strange noise, a burning smell, or smoke is emitted, unplug the power plug immediately and contact your nearest service center.
<input checked="" type="checkbox"/>	The microwave oven has to be positioned so that plug is accessible.
<input type="checkbox"/>	The microwave oven is intended to be used on the counter or counter top use only, the microwave oven shall not be placed in a cabinet.

⚠ WARNING
(Oven function only) - Optional

<input checked="" type="checkbox"/>	WARNING: When the appliance is operated in the combination mode, children should only use the oven under adult supervision due to the temperatures generated.
-------------------------------------	--

<input checked="" type="checkbox"/>	During use the appliance becomes hot. Care should be taken to avoid touching heating elements inside the oven.
<input type="checkbox"/>	WARNING: Accessible parts may become hot during use. Young children should be kept away.
<input type="checkbox"/>	A steam cleaner is not to be used.
<input type="checkbox"/>	WARNING: Ensure that the appliance is switched off before replacing the lamp to avoid the possibility of electric shock.
<input checked="" type="checkbox"/>	WARNING: The appliance and its accessible parts become hot during use. Care should be taken to avoid touching heating elements. Children less than 8 years of age shall be kept away unless continuously supervised.
<input type="checkbox"/>	The temperature of accessible surfaces may be high when the appliance is operating.
<input type="checkbox"/>	The door or the outer surface may get hot when the appliance is operating.
<input type="checkbox"/>	Keep the appliance and its cord out of reach of children less than 8 years.

English - 5

★	This appliance can be used by children aged from 8 years and above and persons with reduced physical, sensory or mental capabilities or lack of experience and knowledge if they have been given supervision or instruction concerning use of the appliance in a safe way and understand the hazards involved. Children shall not play with the appliance. Cleaning and user maintenance shall not be made by children without supervision.
☐	Do not use harsh abrasive cleaners or sharp metal scrapers to clean the oven door glass since they can scratch the surface, which may result in shattering of the glass.
☐	Appliances are not intended to be operated by means of an external timer or separate remote-control system.

This product is a Group 2 Class B ISM equipment. The definition of group 2 which contains all ISM equipment in which radio-frequency energy is intentionally generated and/or used in the form of electromagnetic radiation for the treatment of material, and

EDM and arc welding equipment. For Class B equipment is equipment suitable for use in domestic establishments and in establishments directly connected to a low voltage power supply network which supplies buildings used for domestic purposes.

INSTALLING YOUR MICROWAVE OVEN

Place the oven on a flat level surface 85 cm above the floor. The surface should be strong enough to safely bear the weight of the oven.

1. When you install your oven, make sure there is adequate ventilation for your oven by leaving at least 10 cm (4 inches) of space behind and, on the sides of the oven and 20 cm (8 inches) of space above.
2. Remove all packing materials inside the oven.
3. Install the roller ring and turntable. Check that the turntable rotates freely. (Turntable type model only)
4. This microwave oven has to be positioned so that plug is accessible.

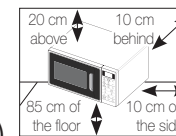

- ❑ If the supply cord is damaged, it must be replaced by the manufacturer, its service agent or similarly qualified persons in order to avoid a hazard.
For your personal safety, plug the cable into a proper AC earthed socket.
- ❑ Do not install the microwave oven in hot or damp surroundings like next to a traditional oven or radiator. The power supply specifications of the oven must be respected and any extension cable used must be of the same standard as the power cable supplied with the oven. Wipe the interior and the door seal with a damp cloth before using your microwave oven for the first time.

CLEANING YOUR MICROWAVE OVEN

The following parts of your microwave oven should be cleaned regularly to prevent grease and food particles from building up:

- Inside and outside surfaces
 - Door and door seals
 - Turntable and Roller rings
(Turntable type model only)
- ❑ **ALWAYS** ensure that the door seals are clean and the door closes properly.

- ❑ Failure to maintain the oven in a clean condition could lead to deterioration of the surface that could adversely affect the life of the appliance and possibly result in a hazardous situation.

1. Clean the outside surfaces with a soft cloth and warm, soapy water. Rinse and dry.
 2. Remove any splashes or stains on the inside surfaces of oven with a soapy cloth. Rinse and dry.
 3. To loosen hardened food particles and remove smells, place a cup of diluted lemon juice in the oven and heat for ten minutes at maximum power.
 4. Wash the dishwasher-safe plate whenever necessary.
- ❑ **DO NOT** spill water in the vents. **NEVER** use any abrasive products or chemical solvents. Take particular care when cleaning the door seals to ensure that no particles:
- Accumulate
 - Prevent the door from closing correctly

- ✎ **Clean** the microwave oven cavity right after each use with a mild detergent solution, but let the microwave oven cool down before cleaning in order to avoid injury.

When cleaning the upper part inside the cavity, it will be convenient to turn heater downward by 45 ° and clean it. (Swing heater model only)

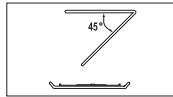

STORING AND REPAIRING YOUR MICROWAVE OVEN

A few simple precautions should be taken when storing or having your microwave oven serviced.

The oven must not be used if the door or door seals are damaged:

- Broken hinge
- Deteriorated seals
- Distorted or bent oven casing

Only a qualified microwave service technician should perform repair.

- ✎ **NEVER** remove the outer casing from the oven. If the oven is faulty and needs servicing or you are in doubt about its condition:

- Unplug it from the wall socket
- Contact the nearest after-sales service centre

- ✎ If you wish to store your oven away temporarily, choose a dry, dustfree place. **Reason :** Dust and damp may adversely affect the working parts in the oven.

- ✎ This microwave oven is not intended for commercial use.

- ✎ The Light bulb should not be replaced in person for safety reasons. Please contact nearest authorised Samsung customer care, to arrange for a qualified engineer to replace the bulb.

⚠ WARNING		🔥	⚡	🚰	👤
✎	Only qualified staff should be allowed to modify or repair the appliance.	✓	✓	✓	✓
✎	Do not heat liquids and other food in sealed containers for microwave function.	✓	✓	✓	✓
✎	For your safety, do not use high-pressure water cleaners or steam jet cleaners.	✓	✓	✓	✓
✎	Do not install this appliance; near heater, inflammable material; in a humid, oily or dusty location, in a location exposed to direct sunlight and water or where gas may leak; on un level ground.	✓	✓	✓	✓
🔌	This appliance must be properly grounded in accordance with local and national codes.	✓	✓	✓	✓

<input checked="" type="checkbox"/>	Remove all foreign substances such as dust or water from the power plug terminals and contact points using a dry cloth on a regular basis.	✓	✓	✓	✓
<input type="checkbox"/>	Do not pull or excessively bend or place heavy object on the power cord.	✓	✓	✓	✓
<input checked="" type="checkbox"/>	In the event of a gas leak (such as propane gas, LP gas, etc.), ventilate immediately without touching the power plug.	✓	✓	✓	✓
<input type="checkbox"/>	Do not touch the power plug with wet hands.	✓	✓	✓	✓
<input type="checkbox"/>	Do not turn the appliance off by unplugging the power plug while an operation is in progress.	✓	✓	✓	✓
<input type="checkbox"/>	Do not insert fingers or foreign substances. If any foreign substance such as water has entered the appliance, unplug the power plug and contact your nearest service centre.	✓	✓	✓	✓
<input type="checkbox"/>	Do not apply excessive pressure or impact to the appliance.	✓	✓	✓	✓
<input type="checkbox"/>	Do not place the oven over a fragile object such as a sink or glass object.	✓	✓		
<input type="checkbox"/>	Do not use benzene, thinner, alcohol, steam cleaner or high pressure cleaner to clean the appliance.	✓	✓	✓	✓
<input type="checkbox"/>	Ensure that the power voltage, frequency and current are the same as those of the product specifications.	✓	✓		✓
<input type="checkbox"/>	Plug the power plug into the wall socket firmly. Do not use a multiple plug adapter, an extension cord or an electric transformer.	✓	✓	✓	
<input type="checkbox"/>	Do not hook the power cord on a metal object, insert the power cord between the objects or behind the oven.	✓	✓	✓	

<input type="checkbox"/>	Do not use a damaged power plug, damaged power cord or loose wall socket. When the power plug or power cord is damaged, contact your nearest service centre.	✓	✓	✓	✓
<input type="checkbox"/>	Do not pour or directly spray water onto the oven.	✓	✓		
<input type="checkbox"/>	Do not place objects on the oven, inside or on the door of the oven.	✓	✓	✓	
<input type="checkbox"/>	Do not spray volatile material such as insecticide onto the surface of the oven.	✓	✓		
<input type="checkbox"/>	Do not store flammable materials in the oven. Take special care when heating dishes or drinks that contain alcohol as alcohol vapours may contact a hot part of the oven.	✓		✓	✓
<input checked="" type="checkbox"/>	Keep children away from the door when opening or closing it as they may bump themselves on the door or catch their fingers in the door.	✓	✓	✓	✓
<input checked="" type="checkbox"/>	WARNING: Microwave heating of beverages can result in delayed eruptive boiling, therefore care must be taken when handling the container; To prevent this situation ALWAYS allow a standing time of at least 20 seconds after the oven has been switched off so that the temperature can equalize. Stir during heating, if necessary, and ALWAYS stir after heating. In the event of scalding, follow these FIRST AID instructions: <ul style="list-style-type: none"> Immerse the scalded area in cold water for at least 10 minutes. Cover with a clean, dry dressing. Do not apply any creams, oils or lotions. 	✓	✓	✓	✓
<input type="checkbox"/>	Do not put the tray or rack in water shortly after cooking because it may cause breakage or damage of the tray or rack.				✓

	Do not operate the microwave oven for deep fat frying because the oil temperature cannot be controlled. This could result in a sudden boil over of the hot liquid.	✓		✓
--	--	---	--	---

⚠ CAUTION				
------------------	--	--	--	--

	Only use utensils that are suitable for use in microwave ovens; DO NOT use any metallic containers, Dinnerware with gold or silver trimmings, Skewers, forks, etc. Remove wire twist ties from paper or plastic bags. Reason: Electric arcing or sparking may occur and may damage the oven.	✓		✓	✓
	Do not use your microwave oven to dry papers or clothes.	✓		✓	✓
	Use shorter times for smaller amounts of food to prevent overheating and burning food.	✓		✓	✓
	Do not immerse the power cable or power plug in water and keep the power cable away from heat.	✓	✓		
	Eggs in their shell and whole hard-boiled eggs should not be heated in microwave ovens since they may explode, even after microwave heating has ended; Also do not heat airtight or vacuum-sealed bottles, jars, containers, nuts in shells, tomatoes etc.			✓	✓
	Do not cover the ventilation slots with cloth or paper. They may catch fire as hot air escapes from the oven. The oven may also overheat and switch itself off automatically, and will remain off until it cools sufficiently.	✓		✓	
	Always use oven mitts when removing a dish from the oven to avoid unintentional burns.			✓	
	Stir liquids halfway during heating or after heating ends and allow the liquid stand at least 20 seconds after heating to prevent eruptive boiling.			✓	

	Stand at arms length from the oven when opening the door to avoid getting scalded by escaping hot air or steam.			✓	
	Do not operate the microwave oven when it is empty. The microwave oven will automatically shut down for 30 minutes for safety purposes. We recommend placing a glass of water inside the oven at all times to absorb microwave energy in case the microwave oven is started accidentally.	✓			✓
	Install the oven in compliance with the clearances stated in this manual. (See installing your microwave oven.)	✓		✓	
	Take care when connecting other electrical appliances to sockets near the oven.	✓	✓	✓	

PRECAUTIONS TO AVOID POSSIBLE EXPOSURE TO EXCESSIVE MICROWAVE ENERGY. (MICROWAVE FUNCTION ONLY)

Failure to observe the following safety precautions may result in harmful exposure to microwave energy.

- (a) Under no circumstances should any attempt be made to operate the oven with the door open or to tamper with the safety interlocks (door latches) or to insert anything into the safety interlock holes.
- (b) Do NOT place any object between the oven door and front face or allow food or cleaner residues to accumulate on sealing surfaces. Ensure that the door and door sealing surfaces are kept clean by wiping after use first with a damp cloth and then with a soft dry cloth.
- (c) Do NOT operate the oven if it is damaged until it has been repaired by a qualified microwave service technician trained by the manufacturer. It is particularly important that the oven door closes properly and that there is no damage to the:
 - (1) door (bent)
 - (2) door hinges (broken or loose)
 - (3) door seals and sealing surfaces
- (d) The oven should not be adjusted or repaired by anyone other than a properly qualified microwave service technician trained by the manufacturer.

Samsung will charge a repair fee for replacing an accessory or repairing a cosmetic defect if the damage to the unit and/or damage to or loss of the accessory was caused by the customer. Items this stipulation covers include:

- (a) A Dented, Scratched, or Broken Door, Handle, Out-Panel, or Control Panel.
 - (b) A Broken or missing Tray, Guide Roller, Coupler, or Wire Rack.
- Use this appliance only for its intended purpose as described in this instruction manual. Warnings and Important Safety Instructions in this manual do not cover all possible conditions and situations that may occur. It is your responsibility to use common sense, caution, and care when installing, maintaining, and operating your appliance.
 - Because these following operating instructions cover various models, the characteristics of your microwave oven may differ slightly from those described in this manual and not all warning signs may be applicable. If you have any questions or concerns, contact your nearest service centre or find help and information online at www.samsung.com.
 - This microwave oven is supposed for heating food. It is intended for domestic home-use only. Do not heat any type of textiles or cushions filled with grains, which could cause burns and fire. The manufacturer cannot be held liable for damage caused by improper or incorrect use of the appliance.
 - Failure to maintain the oven in a clean condition could lead to deterioration of the surface that could adversely affect the life of the appliance and possible result in a hazardous situation.



CORRECT DISPOSAL OF THIS PRODUCT (WASTE ELECTRICAL & ELECTRONIC EQUIPMENT)

(Applicable in countries with separate collection systems)

This marking on the product, accessories or literature indicates that the product and its electronic accessories (e.g. charger, headset, USB cable) should not be disposed of with other household waste at the end of their working life. To prevent possible harm to the environment or human health from uncontrolled waste disposal, please separate these items from other types of waste and recycle them responsibly to promote the sustainable reuse of material resources.

Household users should contact either the retailer where they purchased this product, or their local government office, for details of where and how they can take these items for environmentally safe recycling.

Business users should contact their supplier and check the terms and conditions of the purchase contract. This product and its electronic accessories should not be mixed with other commercial wastes for disposal.

quick look-up guide

If you want to cook some food.

 CBЧ	<ol style="list-style-type: none"> Place the food in the oven. Select the power level by pressing the Power Level button once or more times. 						
<table border="1" style="width: 100%; text-align: center;"> <tr> <td>1</td> <td>Мин</td> <td>100сек</td> </tr> <tr> <td>10Мин</td> <td>Таймер</td> <td></td> </tr> </table>	1	Мин	100сек	10Мин	Таймер		<ol style="list-style-type: none"> Select the cooking time by pressing the 10 min, 1 min or 10 s button as required.
1	Мин	100сек					
10Мин	Таймер						
 СТАРТ	<ol style="list-style-type: none"> Press the Start button. Result: Cooking starts. The oven beeps four times when cooking is over. 						



If you want to defrost some food.

 Ускоренная разморозка	<ol style="list-style-type: none"> Place the frozen food in the oven. Press the Rapid button once or more times according to the type of food to be defrosted.
100Г	<ol style="list-style-type: none"> Select the weight by pressing the 100 g button as required.
 СТАРТ	<ol style="list-style-type: none"> Press the Start button.

If you want to add an extra minute.

+30сек	<p>Leave the food in the oven. Press +30s once or more times for each extra 30 seconds that you wish to add.</p>
--------	---

If you want to grill some food.

 Гриль	<p>1. Preheat the grill to the required temperature, by pressing the Grill, time setting (10 min, 1 min and 10 s) and Start button.</p>
<p>Ч 10МН 1МН 10С</p> <p>МНН ТМНН 10Сек</p>	<p>2. After preheating is finished, Open the door and Place the food on the rack in the oven. Press the Grill button. Select the cooking time by pressing the 10 min, 1 min and 10 s buttons.</p>
 СТАРТ	<p>3. Press the Start button.</p>

oven features

OVEN (GE83*KR*-1, GE83*KR*-2, GE83*KR*-3, GE83KR*-1, GE83KR*-2, GE83KR*-3, GE83KR*-1*, GE83KR*-2*, GE83KR*-3*)

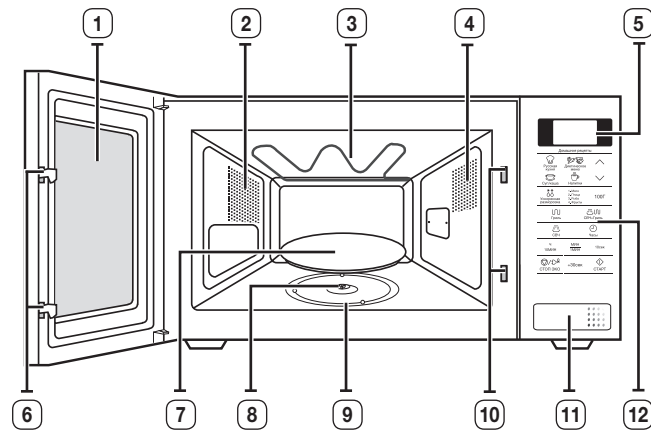

- | | |
|----------------------|----------------------------|
| 1. DOOR | 7. TURNTABLE |
| 2. VENTILATION HOLES | 8. COUPLER |
| 3. GRILL | 9. ROLLER RING |
| 4. LIGHT | 10. SAFETY INTERLOCK HOLES |
| 5. DISPLAY | 11. OPEN DOOR PUSH BUTTON |
| 6. DOOR LATCHES | 12. CONTROL PANEL |

OVEN (GE83MR**)

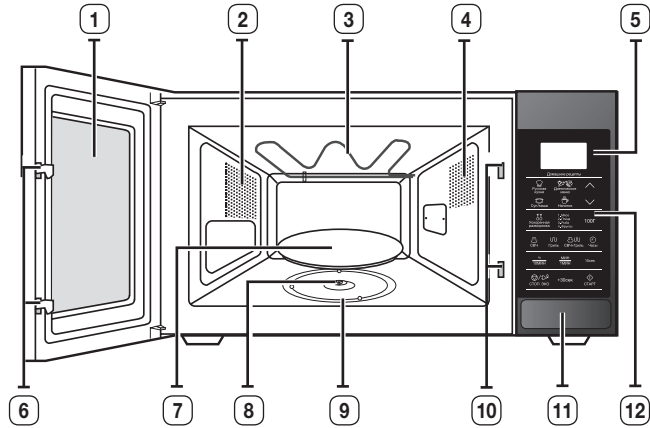

- | | |
|----------------------|----------------------------|
| 1. DOOR | 7. TURNTABLE |
| 2. VENTILATION HOLES | 8. COUPLER |
| 3. GRILL | 9. ROLLER RING |
| 4. LIGHT | 10. SAFETY INTERLOCK HOLES |
| 5. DISPLAY | 11. OPEN DOOR PUSH BUTTON |
| 6. DOOR LATCHES | 12. CONTROL PANEL |

OVEN (GE83AR*)

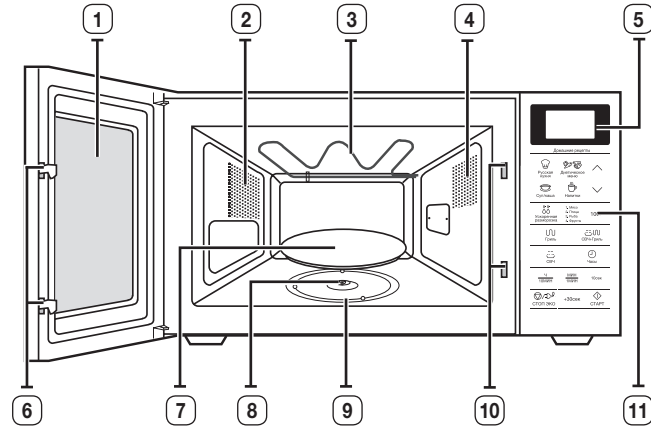

- | | |
|----------------------|----------------------------|
| 1. DOOR | 7. TURNTABLE |
| 2. VENTILATION HOLES | 8. COUPLER |
| 3. GRILL | 9. ROLLER RING |
| 4. LIGHT | 10. SAFETY INTERLOCK HOLES |
| 5. DISPLAY | 11. CONTROL PANEL |
| 6. DOOR LATCHES | |

CONTROL PANEL (GE83*KR*-1, GE83*KR*-2, GE83*KR*-3, GE83KR*-1, GE83KR*-2, GE83KR*-3, GE83KR*-1*, GE83KR*-2*, GE83KR*-3*)

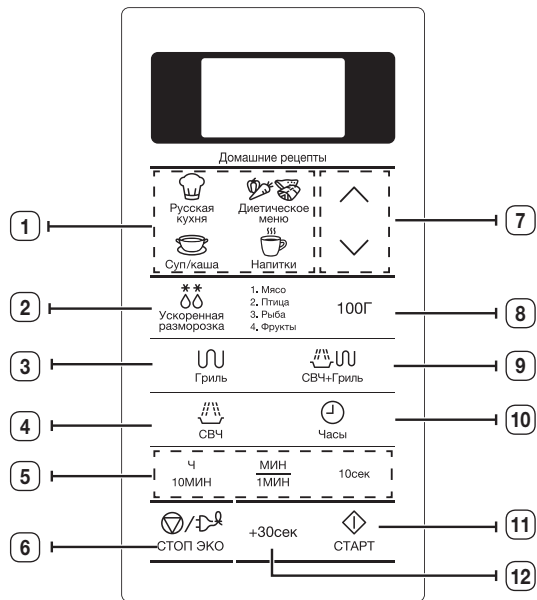

- | | |
|---|--------------------------|
| 1. AUTO RUSSIAN COOK | 7. UP/DOWN BUTTON |
| 2. AUTO RAPID DEFROST FEATURE SELECTION | 8. WEIGHT SELECTION |
| 3. GRILL MODE BUTTON | 9. COMBI MODE BUTTON |
| 4. POWER LEVEL BUTTON | 10. CLOCK SETTING BUTTON |
| 5. TIME SETTING BUTTON | 11. START BUTTON |
| 6. STOP/ENERGY SAVE BUTTON | 12. +30s BUTTON |

CONTROL PANEL (GE83MR**)

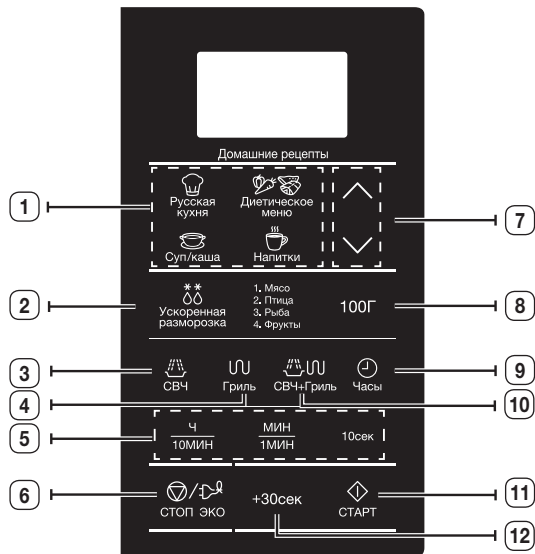

- | | |
|---|-------------------------|
| 1. AUTO RUSSIAN COOK | 7. UP/DOWN BUTTON |
| 2. AUTO RAPID DEFROST FEATURE SELECTION | 8. WEIGHT SELECTION |
| 3. POWER LEVEL BUTTON | 9. CLOCK SETTING BUTTON |
| 4. GRILL MODE BUTTON | 10. COMBI MODE BUTTON |
| 5. TIME SETTING BUTTON | 11. START BUTTON |
| 6. STOP/ENERGY SAVE BUTTON | 12. +30s BUTTON |

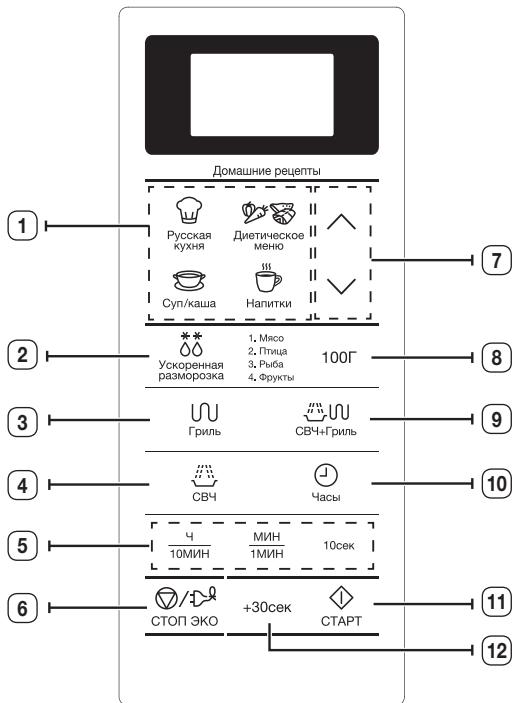

CONTROL PANEL (GE83AR*)



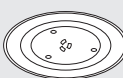

- | | |
|---|--------------------------|
| 1. AUTO RUSSIAN COOK | 7. UP/DOWN BUTTON |
| 2. AUTO RAPID DEFROST FEATURE SELECTION | 8. WEIGHT SELECTION |
| 3. GRILL MODE BUTTON | 9. COMBI MODE BUTTON |
| 4. POWER LEVEL BUTTON | 10. CLOCK SETTING BUTTON |
| 5. TIME SETTING BUTTON | 11. START BUTTON |
| 6. STOP/ENERGY SAVE BUTTON | 12. +30s BUTTON |

ACCESSORIES

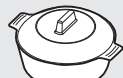
Depending on the model that you have purchased, you are supplied with several accessories that can be used in a variety of ways.

	1. Roller ring , to be placed in the centre of the oven. Purpose: The roller ring supports the turntable.
	2. Turntable , to be placed on the roller ring with the centre fitting to the coupler. Purpose: The turntable serves as the main cooking surface; it can be easily removed for cleaning.
	3. Grill rack , to be placed on the turntable. Purpose: The metal rack can be used in grill and combination cooking.
	4. Steam cooker , see page 28 to 29. (Only GE83KR*-*X models) Purpose: The plastic steam cooker when using power steam function.

-  **DO NOT** operate the microwave oven without the roller ring and turntable.
-  Емкость для приготовления на пару (пароварка) является неотъемлемой частью комплекта поставки микроволновой печи :
*****BW, ***/BWT, ***X/BWT, ***P**/BWT**

HOW A MICROWAVE OVEN WORKS

Microwaves are high-frequency electromagnetic waves; the energy released enables food to be cooked or reheated without changing either the form or the colour.

You can use your microwave oven to:

- Defrost
- Instant Reheat/Cook
- Cook

Cooking Principle.

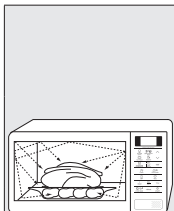

1. The microwaves generated by the magnetron are distributed uniformly as the food rotates on the turntable. The food is thus cooked evenly.
2. The microwaves are absorbed by the food up to a depth of about 1 inch (2.5 cm). Cooking then continues as the heat is dissipated within the food.
3. Cooking times vary according to the recipient used and the properties of the food:
 - Quantity and density
 - Water content
 - Initial temperature (refrigerated or not)

☑ As the centre of the food is cooked by heat dissipation, cooking continues even when you have taken the food out of the oven. Standing times specified in recipes and in this booklet must therefore be respected to ensure:

- Even cooking of the food right to the centre
- The same temperature throughout the food

CHECKING THAT YOUR OVEN IS OPERATING CORRECTLY

The following simple procedure enables you to check that your oven is working correctly at all times. Open the oven door by pushing the large button in the bottom right-hand corner of the control panel.

First, place a bowl of water on the turntable. Then, close the door.

	<p>1. Press the Power Level button and set the time to 4-5 minutes by pressing the 1 min button the appropriate number of times.</p>
	<p>2. Press the Start button. Result: The oven heats the water for 4 to 5 minutes. The water should then be boiling.</p>

☑ The oven must be plugged into an appropriate wall socket. The turntable must be in position in the oven. If a power level other than the maximum is used, the water takes longer to boil.



SETTING THE TIME

Your microwave oven has an inbuilt clock. When power is supplied, “:0”, “88:88” or “12:00” is automatically displayed on the display.

Please set the current time. The time can be displayed in either the 24- hour or 12-hour notation. You must set the clock:

- When you first install your microwave oven
- After a power failure

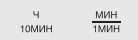
 Do not forget to reset the clock when you switch to and from summer and winter time.



 Часы	1. To display the time in the... 24-hour notation. 12-hour notation.
	2. Set the hour with the h button and the minutes with the min button.
 Часы	3. When the right time is displayed, press the Clock button again to start the clock. Result: The time is displayed whenever you are not using the microwave oven.

COOKING/REHEATING

The following procedure explains how to cook or reheat food.

ALWAYS check your cooking settings before leaving the oven unattended.

First, place the food in the centre of the turntable. Then, close the door.

 СВЧ	1. Press the Power Level button. Result: The 800 W (maximum cooking power) indications are displayed: Select the appropriate power level by pressing the Power Level button again until the corresponding wattage is displayed. Refer to the power level table on the next page.
	2. Set the cooking time by pressing the 10 min, 1 min and 10 s button.
 СТАРТ	3. Press the Start button. Result: The oven light comes on and the turntable starts rotating. 1) Cooking starts and when it has finished the oven beeps four times. 2) The end reminder signal will beep 3 times (once every minute). 3) The current time is displayed again.

 **Never** switch the microwave oven on when it is empty.

POWER LEVELS

You can choose among the power levels below.



Power level	Output	
	MWO	GRILL
HIGH	800 W	-
MEDIUM HIGH	600 W	-
MEDIUM	450 W	-
MEDIUM LOW	300 W	-
DEFROST	180 W	-
LOW / KEEP WARM	100 W	-
GRILL	-	1100 W
COMBI I	600 W	1100 W
COMBI II	450 W	1100 W
COMBI III	300 W	1100 W

 If you select higher power level, the cooking time must be decreased.

 If you select lower power level, the cooking time must be increased.



ADJUSTING THE COOKING TIME

You can increase the cooking time by pressing the +30 s button once for each 30 seconds to be added.

	1. Press the +30 s button once for each 30 seconds to be added.
	2. Press the Start button.

STOPPING THE COOKING

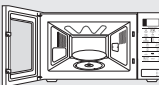
You can stop cooking at any time to check the food.

	1. To stop temporarily; Open the door. Result: Cooking stops. To resume cooking, close the door and press Start again.
	2. To stop completely; Press the Stop button. Result: The cooking stops. If you wish to cancel the cooking settings, press the Stop button again.

 You can cancel any setting before starting cooking by simply pressing **Stop** button.

SETTING THE ENERGY SAVE MODE

The oven has an Energy save mode. This facility saves electricity when the oven is not in use.

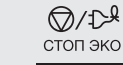
	<ul style="list-style-type: none"> • Press the Energy save button. • To remove Energy save mode, open the door or press any button. Then display shows current time. The oven is ready for use.
--	---



Auto energy saving function

If you do not select any function when appliance is in the middle of setting or operating with temporary stop condition, function is canceled and clock will be displayed after 25 minutes. Oven Lamp will be turned off after 5 minutes with door open condition.

USING THE AUTO RUSSIAN COOK FEATURE

With the Auto Russian Cook feature, the cooking time is set automatically. You can select the food servings by pressing the appropriate Russian Cook button the required number of times.

First, place the food in the centre of the turntable and close the door.

	<p>1. Press the Auto Russian Cook button which you want the required category.</p>
	<p>2. Press the UP/DOWN button to select the food you want.</p>
	<p>3. Press the Start button. Result: When it has finished: 1) The oven beeps four times. 2) The end reminder signal will beep 3 times (once every minute) 3) The current time is displayed again.</p>

 Use only recipients that are microwave-safe.

AUTO RUSSIAN COOK FEATURE/COOK

The following table presents 4 Auto Russian Cook feature /Cook Programmes, quantities, standing times and appropriate recommendations.

1. Russian Menus

Code/Food	Serving Size	Ingredients
1-1 Omlet	130-135 g	Egg – 3 pc, Milk – 30 ml, Salt – 2 g
	Instructions Whisk the egg with milk and salt, pour out egg to a plate. Start cooking.	
1-2 Sausages with canned pea	Sausage – 2 pc Hot pea -132 g	Sausages – 2 pc per 50 g, Butter – 5 g, Canned pea – 135 g (dry weight)
	Instructions Put into a plate pricked sausages without plastic cover, add butter a side. Put on the top of butter canned pea. Start cooking.	
1-3 Keks	180 g	Sugar – 45 g, Vanilla infused sugar – 5 g, Butter – 40 g, Egg – ½ pc, Milk -30 ml, Baking powder -3 g, Wheat – 100 g
	Instructions Mix well sugar, infused sugar and butter. Add beaten egg. Add all next ingredients. Put it into a buttered bowl. Start cooking. Give it cold before removing out the bowl.	
1-4 Lemon shortbread bolls	190 g (5 pc)	Wheat – 100 g, Butter – 50 g, Sugar – 40 g, Egg yolk- ½ pc, Warm water – 1 tbsp, Lemon zests, For topping: Egg yolk- 1 pc, Ice sugar – 3-5 g
	Instructions Mix well all ingredients. Make five balls. Put it on wax paper. Put it on turntable. Start cooking. As soon as oven beeps, grease egg yolk on the balls top, sprinkle with ice sugar and continue cooking process. Leave it to cold.	

(continued)

Code/Food	Serving Size	Ingredients
1-5 Syrniki	2 per 95 g	Custard cheese – 90-100 g, Wheat – 10 g, Sugar (vanilla infused sugar)–10 g, Salt– 0,5 g, Egg – ¼ pc, Butter - 5-10 g (for greasing)
	Instructions All ingredients except butter mix well. Make two tablet forms. Grease on butter to the tablet forms. Put it on wax paper and on grill rack. Start cooking. As soon as oven beeps, upside down tablet forms and continue cooking process.	
1-6 Cheese toast	40-60 g	Toast bread – 2 pc. per 26-28 g, Cheese – 2 pc per 20 g
	Instructions Put on two toasts to the grill rack. Start cooking. As soon as oven beeps, upside down toasts and put on cheese to the toasts. And continue cooking process.	
1-7 Cheese in bread crumbs	125 g (5 pc)	Cheese – 125 g (4-5 pc per 25 g each), Egg – ½ pc, Bread crumbs – 3-5 g
	Instructions Cut cheese into 5 cm x 5 cm square forms. Put into egg yolk and covered with bread crumbs. Preheat the oven 5 min Grill. Put cheese on a wax paper. Then put it on the grill rack. Start cooking.	
1-8 Moscow style fish	270 g	(1) Champignons – 30 g, Pike perch filet - 150 g, Oil – 5 g (2) Sour cream – 30 g (2 x 15 g) (3) Baked potato round cut – 2 pc per 60-70 g, Salt – 5 g, White pepper powder – ½ g, Graded cheese – 25 g
	Instructions Put mushrooms on a plate fish aside. Drop oil on it(1). Start cooking. As soon as oven beeps, put a half of sour cream on a ceramic plate (in the center) (2). Put cooked mushrooms on it. Put Fish on it. Season it. Put around fish cut potato. Put on potato cheese(3). Continue cooking process	

Code/Food	Serving Size	Ingredients
1-9 Grilled salmon steak	150-170 g	Salmon steak with bone and skin – 200-250 g, Salt – 1 g, Lemon – 15 g (squeeze juice), Oil - 5 g
	Instructions Salmon steak season, oil. Put it on a plate. Put the plate on the grill rack. Start cooking. As soon as oven beeps, upside down steak. And continue cooking process.	
1-10 Chicken legs with prunes	325 g 2 pc.	Onion julienned – 15 g, Carrot julienned – 20 g, Chicken legs – 2 pc. (160-180 g), Prunes – 5-7 pc. (50 g), Chicken stock or water with dry concentrate - 150 ml
	Instructions Put onion and carrot into a plate. Put chicken legs on it, add prunes and the stock. Put the plate in microwave oven. Start cooking. As soon as oven beeps, upside down it and continue cooking process.	
1-11 Pork neck with mustard sauce	250 g	(1) Pork neck – 150 g, Carrot graded – 20 g, Onion julienned – 20 g, Chicken stock or water with dry concentrate - 100 ml (2) Mix for sauce: Wheat – 5 g, Dijon mustard – 20 g, Sour Cream – 30 g, Water – 50 ml
	Instructions Cut meat into batons, prepare vegetables.add chicken stock.(1) Pour into a plate. Mix well and start cooking. Prepare all ingredients for the mix for sauce(2). As soon as oven beeps, Pour the mix into stock with meat, mix it and continue cooking process.	

Code/Food	Serving Size	Ingredients
1-12 Trout baked with vegetables	210-240 g	Butter – 5 g, Carrot julienned – 35 g, Onion julienned – 25 g, Garlic chopped -3 g, Celery leaves chopped – 5 g, Trout – 1 pc– 220-250 g, Salt – 1 g, White pepper powder – ½ g, Butter – 5 g
	Instructions Grease butter in the centre of wax paper. Put carrot, onion, garlic and celery on it. Put seasoned trout on vegetables. Grease butter on top of the fish. Cover it. Put it into microwave oven and start cooking.	
1-13 Meatloaf with hard boiled egg	180 g	Minced meat (beef & pork) - 150 g, Hardboiled egg – 1 pc, Salt – 2 g, Black pepper powder – ½ g
	Instructions Add spice into meat and mix hard by hand. Roll meat into round form. Put in the center of meat round the egg. Cover the egg by meat from all side. Form it in arc form. Put it on a plate. Put the plate on the grill rack. Start cooking.	
1-14 Golubtci leniyye	225 g 2 pc.	(1) Meat ovals (a) Minced meat (beef & pork) - 120 g, Cooked regular rice – 25 g, Cabbage chopped – 25 g, Salt – 1- 2 g, Black pepper powder – ½ g (b) Onion julienned – 30 g, Beef stock or water with dry concentrate - 100 ml (2) Mix for sauce: Wheat – 5 g, Tomato paste – 10 g, Sour Cream – 30 g, Water – 50 ml
	Instructions Add vegetables and spice into meat and mix hard by hand(a). Form it in two ovals. Put onion into a bowl shaped plate. Put meat ovals on it, add the stock(b). Put the plate on the grill rack. Start cooking. Prepare all ingredients for the Mix for sauce(2). As soon as oven beeps, pour the mix into stock with meat ovals. Upside down it and continue cooking process.	

Code/Food	Serving Size	Ingredients
1-15 Cutlets	114 g 2 pc	(1) White bread - 10 g, Milk – 15 ml (2) Pork & beef minced meat 120 g, Salt – 2 g, Black pepper – 1 g (3) Bread crumbs – 5 g
	Instructions Drop milk to bread(1). Mix it well with minced meat. Add spices(2). Form it in two balls, cover with bread crumbs(3). Put it on a plate. Start cooking.	
1-16 Baked potato	140-180 g 1-2 pc	Big size potato– 160-200 g, 1 - 2 pc
	Instructions Wash potatoes and prick the skin with fork. Put in microwave. Start cooking. Put butter or sour cream or cheese or something else before serving.	
1-17 Ratatouille	260 g	Zucchini diced– 100 g, Carrot diced – 60 g, Bell pepper diced – 75 g, Onion diced – 45 g, Garlic chopped– 6 g, Tomato paste – 10 g, (Oregano and Basil to taste), Vegetables stock or water with dry concentrate - 150 ml
	Instructions Put all ingredients into a bowl shaped plate. (Add oregano & basil). Mix well. Start cooking.	
1-18 Russian old style fish	340 g	(1) Beetroot julienned – 30 g, Carrot julienned – 30 g, Onion julienned – 15 g, Fish\Chicken stock or water with dry concentrate - 200 ml (2) Mix for sauce: Wheat – 10 g, Tomato paste – 10 g, Sour cream – 30 g, Water – 50 ml (3) Carp or pike perch filet– 150 g, Bay leaf – 1 pc
	Instructions Put all ingredients into a bowl shaped plate add boiling stock. (1) Start cooking. As soon as oven beep, stir in „mix for sauce“ with veg and stock (2). Add fish and bay leaf (3). Continue cooking process.	

(continued)

Code/Food	Serving Size	Ingredients
1-19 Frozen pizza	370 g	Frozen pizza – 350 g
	Instructions Put frozen pizza with wax paper on the grill rack. Start cooking.	
1-20 Salmon shashlik	280 g	Salmon big diced– 350-370 g, Lemon – 25 g (squeeze juice), Salt – 5 g, Oil – 10 g, Parsley chopped – 10 g, Sticks.
	Instructions Mix all ingredients and fish. Marinate 15-20 min. Put on sticks it. Put it on the plate and on the grill rack. Start cooking.	
1-21 Myaso po-boyrski	260 g	Pork neck – 280 g cut in 4 pieces, Salt – 2 g, Black pepper powder – ½ g, Champignons slices– 45 g, Mayonnaise – 55 g
	Instructions Season meat. Put meat on the plate. Put plate on the grill rack. Start cooking. As soon as oven beeps, put champignons on meat and cover with mayonnaise. Continue cooking process.	
1-22 Kulebyaka s semgoy	180 g	Frozen puff pastry – 130 g, Filling: Salmon filet small diced – 100 g, Salt – 1 g, Pan fried onion diced-20 g, Hardboiled egg small diced – 30 g, Egg yolk – 1 pc for brushing
	Instructions Defrost pastry. Roll it to 2 mm thin. Mix all ingredients for filling. Put filling in the center of pastry. Combine ends of the pastry together. Form it. Make some cuts. Brush it by egg yolk. Preheat the oven 5 min Grill. Put formed pastry on a wax paper. Then put it on the grill rack. Start cooking. As soon as oven beeps, remove wax paper. Upside down formed pastry. Continue cooking process.	

Code/Food	Serving Size	Ingredients
1-23 Krupenik	224 g	(a) Custard cheese 9 %- 120-140 g, Sugar – 10- 15 g, Salt – ½ g, Egg – ½ pc, Ready cooked buckwheat – 140 g (b) Butter – 5 g, Bread crumbs– 1-2 g (c) Sour cream – 30 g
		Instructions Mix all ingredients(a). Put into buttered and covered with bread crumbs bowl shaped plate(b). Cover sour cream on top(c). Start cooking.
1-24 Chicken shashlik	280 g	Chicken leg filet–380 g, Tomato paste – 20 g, Salt – 5 g, Garlic chopped – 3 g, Oil – 7 g, Regular yogurt – 70 g Sticks
		Instructions Cut filet into 3 cm x 3 cm dices. Mix all ingredients for marinate. Mix marinate with chicken filet. Put on sticks it. Put it on the plate and on the grill rack. Start cooking.
1-25 Bell pepper stuffed with meat	480-500 g 2 pc	(1) Bell pepper – 2 pc. per 80 g, Minced meat (beef & pork).- 150-190 g (divide to two part), Cooked regular rice – 10-20 g, Salt – 5 g, Black pepper powder – ½ g, Beef stock or water with dry concentrate - 200 ml (2) Mix for sauce: Wheat – 5 g, Tomato paste – 10 g, Water – 50 ml
		Instructions Add rice inside minced meat. Season it and mix hard by hand. Remove the center and seeds from the pepper. Stuff pepper by meat. Put it into a bowl shaped plate add stock(1). Start cooking. Prepare all ingredients for the Mix for sauce(2). As soon as oven beeps, pour the mix into stock with stuffed pepper. Upside down it and continue cooking process.

Code/Food	Serving Size	Ingredients
1-26 Meat balls in tomato sauce	265 g 2 pc.	(1) Meat balls (a) White bread- 30 g, Milk – 35 ml, Minced meat (beef & pork).- 130 g, Salt – 1- 2 g, Black pepper powder – ½ g (b) Onion julienned - 15 g, Carrot julienned – 30 g, Beef stock or water with dry concentrate - 100 ml (2) Mix for sauce: Wheat – 5 g, Tomato paste – 10 g, Water – 50 ml
	Instructions Put bread into milk. Add it inside minced meat. Season it and mix hard by hand(a). Form it in two balls. Put onion and carrot into a bowl shaped plate(b). Put meat balls on it, add the stock. Put the plate on the grill rack. Start cooking. Prepare all ingredients for the Mix for sauce(2). As soon as oven beeps, pour the mix into stock with meat balls. Upside down it and continue cooking process.	
1-27 Turkey steamed with vegetables	315 g	Turkey filet batons-150 g, Zucchini julienned - 50 , Onion julienned – 15 g, Carrot julienned – 20 g, Chicken stock or water with dry concentrate - 100 ml
	Instructions Put all ingredients into a bowl shaped plate add boiling stock.Start cooking. As soon as oven beeps, upside down it, mix veg and continue cooking process.	

2. Soup Menus

Code/Food	Serving Size	Ingredients
2-1 Porridge	260 g	Dry Russian porridge «Hercules» - 50 g, Sugar – 5 g, Salt – 0,5 g, Boiling water– 200 ml, Cold Milk– 100 ml
	Instructions Put into a bowl shaped plate dry porridge, sugar, salt. Add boiling water, milk, mix well. Start cooking.	

Code/Food	Serving Size	Ingredients
2-2 Meat solyanka	340 g	(1) Onion julienned – 45 g, Beef stock or water with dry concentrate -350 ml (2) Capers – 7 g, Salted cucumber graded – 50 g, Tomato paste – 10 g, Black Olives – 16 g, Liquid of Black Olives – 20 ml, Bay leaf -1 pc, Meat assorted – 30 g, Beef stock or water with dry concentrate -350 ml
	Instructions Put onion into a big bowl, add boiling stock(1) .Start cooking. As soon as oven beeps, add all next ingredients(2). Mix well, add stock, bay leaf and continue cooking process.	
2-3 Borch	340 g	(1) Beetroot graded- 50 g, Cabbage julienned – 20 g, Carrot graded -15 g, Onion c julienned - 10 g, Tomato paste- 15 g, Sugar- 5 g (2) Beef stock or water with dry concentrate - 650 ml, Bay leaf -1 pc, Russian vinegar 9 %- 5 ml if you like
	Instructions Put all ingredients into a big bowl (1), add hot stock and start cooking. As soon as oven beeps, add bay leaf. Mix well and continue cooking process.	
2-4 Chicken noodle soup	350 g	Vermicelli – 10 g, Chicken filet – 50 g, Carrot graded – 15 g, Onion julienned – 10 g, Chicken stock or water with dry concentrate - 440 ml
	Instructions Put vermicelli into a big bowl, add boiling stock. Add all next ingredients. Mix well and start cooking.	

(continued)

Code/Food	Serving Size	Ingredients
2-5 Schi	350 g	(1) Cabbage julienned – 45 g, Carrot graded – 15 g, Onion julienned – 10 g, Potato batons – 25 g, Tomato paste – 10 g, Beef stock or water with dry concentrate - 400 ml (2) Beef stock or water with dry concentrate -100 ml, Bay leaf -1 pc
	Instructions Put all ingredients(1) into a big bowl, add boiling stock. Start cooking. As soon as oven beeps, mix well, add stock, bay leaf(2). And continue cooking process.	
2-6 Vegetable soup	350 g	Frozen vegetables – 150 g, Vegetable stock or water with dry concentrate - 300 ml
	Instructions Put all ingredients into a big bowl, add boiling stock. Start cooking.	
2-7 Korean ramen	120 g (1 package)	Korean Ramen 1 package, Water(Room temperature) – 550 ml
	Instructions Remove a package and put noodle, all soup and water (550 ml) in microwave-safe bowl. Stir well. Cover with cling film and pierce at several times. Put them into microwave and start cooking.	
2-8 Soup with pelmeni	185 g (15 pc)	Frozen Pelmeni – 15 pc (10-12 g one piece), Chicken stock or water with dry concentrate - 400 ml, Whole black pepper – 3-5 pc., Bay leaf – 1 pc.
	Instructions Put all ingredients into a big bowl plate, add boiling stock. As soon as oven beeps, mix upside down. Cover with a plastic bowl shaped lid. Start cooking.	
2-9 Buckwheat	200 g	Buckwheat – 100 g, Salt – 2 g, Boiling water – 300 ml
	Instructions Put into a bowl shaped plate buckwheat, salt. Add boiling water, mix well. Start cooking.	

3. Vegetable Menus

Code/Food	Serving Size	Instructions
3-1 Broccoli	250 g	Rinse and clean fresh broccoli and prepare florets. Put them evenly into a glass bowl with lid. Add 30 ml (2 tablespoons) water when cooking for 250 g. Put bowl in the centre of turntable. Cook covered. Stir after cooking. Stand for 1-2 minutes.
3-2 Carrots	250 g	Rinse and clean carrots and prepare even slices. Put them evenly into a glass bowl with lid. Add 30 ml (2 tablespoons) water when cooking for 250 g. Put bowl in the centre of turntable. Cook covered. Stir after cooking. Stand for 1-2 minutes.
3-3 Green beans	250 g	Rinse and clean green beans. Put them evenly into a glass bowl with lid. Add 30 ml (1 tablespoon) water when cooking 250 g. Put bowl in the centre of turntable. Cook covered. Stir after cooking. Stand for 1-2 minutes.
3-4 Spinach	150 g	Rinse and clean spinach. Put into a glass bowl with lid. Do not add water. Put bowl in the centre of turntable. Cook covered. Stir after cooking. Stand for 1-2 minutes.
3-5 Corn on the cob	500 g (2 pcs)	Rinse and clean corn on the cobs and put into an oval glass dish. Cover with microwave cling film and pierce film. Stand for 1-2 minutes.
3-6 Peeled potatoes	250 g	Wash and peel the potatoes and cut into a similar size. Put them into a glass bowl with lid. Add 45-60 ml (3-4 tablespoons) water. Put bowl in the centre of turntable. Cook covered. Stand for 2-3 minutes.
3-7 Brown rice (Parboiled)	250 g	Use a large glass ovenware dish with lid. Add double quantity of cold water (500 ml). Cook covered. Stir before standing time and add salt and herbs. Stand for 5-10 minutes.

Code/Food	Serving Size	Instructions
3-8 Wholemeal macaroni	250 g	Use a large glass ovenware dish with lid. Add 1 liter hot boiling water, a pinch of salt and stir well. Cook uncovered. Cook covered. Stir before standing time and drain thoroughly afterwards. Stand for 1 minute.
3-9 Quinoa	250 g	Use a large glass ovenware dish with lid. Add double quantity of cold water (500 ml). Cook covered. Stir before standing time and add salt and herbs. Stand for 1-3 minutes.
3-10 Bulgur	250 g	Use a large glass ovenware dish with lid. Add double quantity of cold water (500 ml). Cook covered. Stir before standing time and add salt and herbs. Stand for 2-5 minutes.
3-11 Vegetables gratin	500 g	Put the vegetables, such as precooked potato slices, courgette slices and tomatoes and sauce into a suitable sized glass pyrex dish. Add grated cheese on top. Put dish on the rack. Stand for 2-3 minutes.
3-12 Grilled tomatoes	400 g	Rinse and clean tomatoes, cut them into halves and put in an ovenware dish. Add grated cheese on top. Put dish on rack. Stand for 1-2 minutes.



4. Special Occasions

Code/Food	Serving Size	Ingredients
4-1 Cranberry MORS	200 ml	Frozen cranberry – 50 g, Sugar – 35 g, Water – 200 ml
	Instructions Frozen cranberry cut by mincer. Put all ingredients into a big bowl. Start cooking. Cool and strain.	
4-2 Dry fruit compote	200 ml	Dry apricot – 25 g, Prune – 20 g, Dry apple – 15 g, Sugar – 10 g, Lemon acid – 2 dash, Boiling water – 450 ml
	Instructions Put all ingredients into a big bowl, add boiling water. Start cooking.	

USING THE AUTO RAPID DEFROST FEATURE

The Auto Rapid Defrost feature enables you to defrost meat, poultry, fish, fruit/berry. The defrost time and power level are set automatically. You simply select the programme and the weight.

First, place the frozen food in the centre of the turntable and close the door.

	1. Select the type of food that you are cooking by pressing the Rapid Defrost button one or more times. (Refer to the table on the opposite page for further details)
	2. Select the food weight by pressing the 100 g button. It is possible to set up to a maximum of 1500 g.
	3. Press the Start button. Result: <ul style="list-style-type: none"> • Defrosting begins. • The oven beeps halfway through defrosting to remind you to turn the food over. • Press Start button again to finish defrosting.

 You can also defrost food manually. To do so, select the microwave cooking/reheating function with a power level of 180 W. Refer to the section entitled "Cooking/Reheating" on page 17 for further details.

 Use only dishes that are microwave-safe.

AUTO RAPID DEFROST SETTINGS

The following table presents the various Auto Rapid Defrost programmes, quantities, standing times and appropriate recommendations.



Remove all kinds of package material before defrosting. Place meat, poultry, fish and fruit/Berry on a ceramic plate.

Code/Food	Serving Size	Instructions
1 Meat	200-1500 g	Shield the edges with aluminium foil. Turn the meat over when the oven beeps. This programme is suitable for beef, lamb, pork, steaks, chops and minced meat. Stand for 10-30 minutes.
2 Poultry	200-1500 g	Shield the leg and wing tips with aluminium foil. Turn the poultry over when the oven beeps. This programme is suitable for whole chicken and chicken portions. Stand for 10-30 minutes.
3 Fish	200-1500 g	Shield the tail of the whole fish with aluminium foil. Turn the fish over when the oven beeps. This programme is suitable for whole fishes and fish fillets. Stand for 10-30 minutes.
4 Fruit/Berry	100-600 g	Spread fruits evenly into a flat glass dish. This programme is suitable for all kind of fruits. Stand for 5-30 minutes.

 Select the Manual Defrosting function with a power level of 180 W if you want to defrost food manually. For further details on manual defrosting and defrosting time, refer to the page 35.

GRILLING

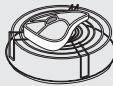
The grill enables you to heat and brown food quickly, without using microwaves. To this aim, a grill rack is supplied with your microwave oven.



	1. Preheat the grill to the required temperature, by pressing the Grill , time setting (10 min, 1 min and 10 s) and Start button.
	2. After preheating is finished, Open the door and place the food on the rack.
	3. Press the Grill button. Select the cooking time by pressing the 10 min, 1 min and 10 s buttons. (The maximum grilling time is 60 minute.)
	4. Press the Start button. Result: The oven light comes on and the turntable starts rotating. 1) Cooking starts and when it has finished the oven beeps four times. 2) The end reminder signal will beep 3 times (once every minute). 3) The current time is displayed again..





 Do not worry if the heater turns off and on while grilling. This system is designed to prevent overheating of the oven.



 Always use oven gloves when touching the dishes in the oven, as they will be very hot.

COMBINING MICROWAVES AND THE GRILL

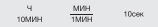
You can also combine microwave cooking with the grill, to cook quickly and brown at the same time.

-  **ALWAYS** use microwave-safe and oven-proof cookware. Glass or ceramic dishes are ideal as they allow the microwaves to penetrate the food evenly.
-  **ALWAYS** use oven gloves when touching the recipients in the oven, as they will be very hot.

	<ol style="list-style-type: none"> 1. Open the oven door by pushing the large button in the bottom right-hand corner of the control panel. Place the food on the rack and the rack on the turntable. Close the door.
 СВЧ+Гриль	<ol style="list-style-type: none"> 2. Press the Combi button. Result: The following indications are displayed: Combi (microwave and grill mode) 600 W (out power)
	<ol style="list-style-type: none"> 3. Set the cooking time by pressing the 10 min, 1 min and 10 s buttons. The maximum cooking time is 60 minutes.
 СТАРТ	<ol style="list-style-type: none"> 4. Press the Start button. Result: Combination cooking starts. When it has finished. <ol style="list-style-type: none"> 1) The oven beeps four times. 2) The end reminder signal will beep 3 times (once every minute). 3) The current time is displayed again.

-  The maximum microwave power for the combined microwave and grill mode is 600 W.
-  Select the appropriate **Power Level** by pressing the **Combi** button again until the corresponding power level is displayed.
-  You cannot set the temperature of the grill.

CHOOSING THE ACCESSORIES

Use microwave-safe recipients; do not use plastic containers, dishes, paper cups, towels, etc.

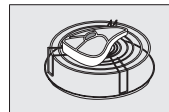





If you wish to select the combined cooking mode (grill and microwave), use only dishes that are microwave-safe and oven-proof

-  For further details on suitable cookware and utensils, refer to the Cookware Guide on page 30.

SWITCHING THE BEEPER OFF



You can switch the beeper off whenever you want.

 СТОП ЭКО	<ol style="list-style-type: none"> 1. Press the Stop and Start buttons at the same time. Result: The oven will not beep each time you press a button. <ul style="list-style-type: none"> • The following indication is displayed. 
 СТОП ЭКО	<ol style="list-style-type: none"> 2. To switch the beeper back on, press the Stop and Start buttons again at the same time. Result: The oven operates with the beeper on again. <ul style="list-style-type: none"> • The following indication is displayed. 

SAFETY-LOCKING YOUR MICROWAVE OVEN

Your microwave oven is fitted with a special Child Safety programme, which enables the oven to be “locked” so that children or anyone unfamiliar with it cannot operate it accidentally.

The oven can be locked at any time.

	<p>1. Press the Stop and Clock buttons at the same time.</p> <p>Result: The oven is locked (no functions can be selected).</p> <ul style="list-style-type: none">The display shows “L”. 
	<p>2. To unlock the oven, press the Stop and Clock buttons again at the same time.</p> <p>Result: The oven can be used normally.</p>

POWER STEAM COOKING GUIDE (ONLY GE83KR*-*X MODELS)

The Power Steamer is based on the principle of steam cooking, and is designed for fast, healthy cooking in your Samsung Microwave oven.

This accessory is ideal for cooking rice, pasta, vegetables, etc. in record time, while preserving their nutritional values.

The Microwave Power steamer set is made up of 3 items:



Bowl



Insert tray

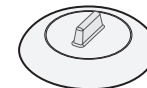

Lid

All parts withstand temperatures from -20 °C to 140 °C.

Suitable for freezer storage. Can also be used separately or together.

CONDITIONS of USE:

- Do not use:
 - to cook foods with a high sugar or fat content,
 - with the grill or rotating heat function or on a hob.
- Wash all parts well in soapy water before first use.
- To find out cooking times, please refer to the instructions in the table on next page.

MAINTENANCE:

- Your steamer can be washed in a dishwasher.
- When washing by hand, use hot water and washing-up liquid. Do not use abrasive pads.
- Some foods (such as tomato) may discolour the plastic. This is normal and not a manufacturing fault.

COOKING:



Food	Serving Size	Power levels	Cooking time (min.)	Handling
Artichokes	300 g (1-2 pcs)	800 W	5-6	Bowl with insert tray + Lid
	Instructions Rinse and clean artichokes. Put insert tray into bowl. Set artichokes on tray. Add 1 tbsp lemon juice. Cover with lid. Stand for 1-2 minutes.			
Fresh Vegetables	300 g	800 W	4-5	Bowl with insert tray + Lid
	Instructions Weigh the vegetables (e.g. broccoli, cauliflower, carrots, pepper) after washing, cleaning and cutting into similar size. Put tray into bowl. Distribute vegetables on insert tray. Add 2 tbsp water. Cover with lid. Stand for 1-2 minutes.			
Frozen Vegetables	300 g	600 W	7-8	Bowl with insert tray + Lid
	Instructions Put the frozen vegetables into the steam bowl. Put insert tray into bowl. Add 1 tbsp water. Cover with lid. Stir well after cooking and standing. Stand for 2-3 minutes.			
Rice	250 g	800 W	15-18	Bowl + Lid
	Instructions Put rice into the steam bowl. Add 500 ml cold water. Cover with lid. After cooking let stand white rice 5 minutes, brown rice 10 minutes.			
Jacket Potatoes	500 g	800 W	7-8	Bowl + Lid
	Instructions Weigh and rinse the potatoes and put them into steam bowl. Add 3 tbsp water. Cover with lid. Stand for 2-3 minutes.			
Stew (Chilled)	400 g	600 W	5-6	Bowl + Lid
	Instructions Put stew into the steam bowl. Cover with lid. Stir well before standing. Stand for 1-2 minutes.			

Food	Serving Size	Power levels	Cooking time (min.)	Handling
Soup (Chilled)	400 g	800 W	3-4	Bowl + Lid
	Instructions Pour into steam bowl. Cover with lid. Stir well before standing. Stand for 1-2 minutes.			
Frozen Soup	400 g	800 W	8-10	Bowl + Lid
	Instructions Put frozen soup into steam bowl. Cover with lid. Stir well before standing. Stand for 2-3 minutes.			
Frozen Yeast Dumpling with Jam Filling	150 g	600 W	1-2	Bowl + Lid
	Instructions Moist the top of filled dumplings with cold water. Put 1-2 frozen dumplings side by side into the steam bowl. Cover with lid. Stand for 2-3 minutes.			
Fruit Compote	250 g	800 W	3-4	Bowl + Lid
	Instructions Weigh the fresh fruits (e.g. apples, pears, plums, apricots, mangoes or pineapple) after peeling, washing and cutting into similar sizes or cubes. Put into steam bowl. Add 1-2 tbsp water and 1-2 tbsp sugar. Cover with lid. Stand for 2-3 minutes.			

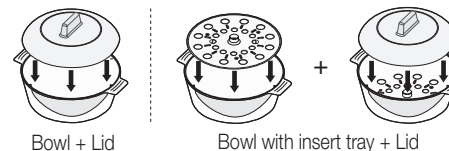
Handling of power steam cooker



PRECAUTIONS:

-  Take special care when opening the lid of your steamer, because the steam escaping may be very hot.
-  Use oven gloves when handling after cooking.

cookware guide

To cook food in the microwave oven, the microwaves must be able to penetrate the food, without being reflected or absorbed by the dish used.

Care must therefore be taken when choosing the cookware. If the cookware is marked microwave-safe, you do not need to worry.

The following table lists various types of cookware and indicates whether and how they should be used in a microwave oven.

Cookware	Microwave-safe	Comments
Aluminum foil	✓ X	Can be used in small quantities to protect areas against overcooking. Arcing can occur if the foil is too close to the oven wall or if too much foil is used.
Browning plate	✓	Do not preheat for more than eight minutes.
China and earthenware	✓	Porcelain, pottery, glazed earthenware and bone china are usually suitable, unless decorated with a metal trim.
Disposable polyester cardboard dishes	✓	Some frozen foods are packaged in these dishes.
Fast-food packaging		
• Polystyrene cups containers	✓	Can be used to warm food. Overheating may cause the polystyrene to melt.
• Paper bags or newspaper	X	May catch fire.
• Recycled paper or metal trims	X	May cause arcing.

Cookware	Microwave-safe	Comments
Glassware		
• Oven-to-table ware	✓	Can be used, unless decorated with a metal trim.
• Fine glassware	✓	Can be used to warm foods or liquids. Delicate glass may break or crack if heated suddenly.
• Glass jars	✓	Must remove the lid. Suitable for warming only.
Metal		
• Dishes	X	May cause arcing or fire.
• Freezer bag twist ties	X	
Paper		
• Plates, cups, napkins and Kitchen paper	✓	For short cooking times and warming. Also to absorb excess moisture.
• Recycled paper	X	May cause arcing.
Plastic		
• Containers	✓	Particularly if heat-resistant thermoplastic. Some other plastics may warp or discolour at high temperatures. Do not use Melamine plastic.
• Cling film	✓	Can be used to retain moisture. Should not touch the food. Take care when removing the film as hot steam will escape.
• Freezer bags	✓ X	Only if boilable or oven-proof. Should not be airtight. Prick with a fork, if necessary.
Wax or grease-proof paper	✓	Can be used to retain moisture and prevent spattering.

✓ : Recommended

✓ X : Use Caution

X : Unsafe

cooking guide

MICROWAVES

Microwave energy actually penetrates food, attracted and absorbed by its water, fat and sugar content.

The microwaves cause the molecules in the food to move rapidly. The rapid movement of these molecules creates friction and the resulting heat cooks the food.

COOKING

Cookware for microwave cooking:

Cookware must allow microwave energy to pass through it for maximum efficiency. Microwaves are reflected by metal, such as stainless steel, aluminium and copper, but they can penetrate through ceramic, glass, porcelain and plastic as well as paper and wood. So food must never be cooked in metal containers.

Food suitable for microwave cooking:

Many kinds of food are suitable for microwave cooking, including fresh or frozen vegetables, fruit, pasta, rice, grains, beans, fish, and meat. Sauces, custard, soups, steamed puddings, preserves, and chutneys can also be cooked in a microwave oven. Generally speaking, microwave cooking is ideal for any food that would normally be prepared on a hob. Melting butter or chocolate, for example (see the chapter with tips, techniques and hints).

Covering during cooking

To cover the food during cooking is very important, as the evaporated water rises as steam and contributes to cooking process. Food can be covered in different ways: e.g. with a ceramic plate, plastic cover or microwave suitable cling film.

Standing times

After cooking is over food the standing time is important to allow the temperature to even out within the food.

Cooking guide for frozen vegetables

Use a suitable glass pyrex bowl with lid. Cook covered for the minimum time - see table. Continue cooking to get the result you prefer.

Stir twice during cooking and once after cooking. Add salt, herbs or butter after cooking. Cover during standing time.

Food	Serving Size	Power	Time (min.)
Spinach	150 g	600 W	4½-5½
	Instructions Add 15 ml (1 tbsp) cold water. Stand for 2-3 minutes.		
Broccoli	300 g	600 W	9-10
	Instructions Add 30 ml (2 tbsp) cold water. Stand for 2-3 minutes.		
Peas	300 g	600 W	7½-8½
	Instructions Add 15 ml (1 tbsp) cold water. Stand for 2-3 minutes.		
Green Beans	300 g	600 W	8-9
	Instructions Add 30 ml (2 tbsp) cold water. Stand for 2-3 minutes.		
Mixed Vegetables (Carrots/Peas/ Corn)	300 g	600 W	7½-8½
	Instructions Add 15 ml (1 tbsp) cold water. Stand for 2-3 minutes.		
Mixed Vegetables (Chinese Style)	300 g	600 W	8-9
	Instructions Add 15 ml (1 tbsp) cold water. Stand for 2-3 minutes.		

Cooking Guide for rice and pasta

Rice : Use a large glass pyrex bowl with lid - rice doubles in volume during cooking. Cook covered.
After the cooking time is over, stir before standing time and salt or add herbs and butter.
Remark: the rice may not have absorbed all water after the cooking time is finished.

Pasta : Use a large glass pyrex bowl. Add boiling water, a pinch of salt and stir well. Cook uncovered.
Stir occasionally during and after cooking. Cover during standing time and drain thoroughly afterwards.

Food	Serving Size	Power	Time (min.)
White Rice (Parboiled)	250 g	800 W	16-17
	Instructions Add 500 ml cold water. Stand for 5 minutes.		
Brown Rice (Parboiled)	250 g	800 W	21-22
	Instructions Add 500 ml cold water. Stand for 5 minutes.		
Mixed Rice (Rice + Wild Rice)	250 g	800 W	17-18
	Instructions Add 500 ml cold water. Stand for 5 minutes.		
Mixed Corn (Rice + Grain)	250 g	800 W	18-19
	Instructions Add 400 ml cold water. Stand for 5 minutes.		
Pasta	250 g	800 W	11-12
	Instructions Add 1000 ml hot water. Stand for 5 minutes.		

Cooking Guide for fresh vegetables

Use a suitable glass pyrex bowl with lid. Add 30-45 ml cold water (2-3 tbsp) for every 250 g unless another water quantity is recommended – see table. Cook covered for the minimum time – see table. Continue cooking to get the result you prefer. Stir once during and once after cooking. Add salt, herbs or butter after cooking.
Cover during a standing time of 3 minutes.

Hint : Cut the fresh vegetables into even sized pieces. The smaller they are cut, the quicker they will cook.

Food	Serving Size	Power	Time (min.)
Broccoli	250 g	800 W	4-4½
	500 g		7-7½
Instructions Prepare even sized florets. Arrange the stems to the centre. Stand for 3 minutes.			
Brussels Sprouts	250 g	800 W	5½-6½
	Instructions Add 60-75 ml (4-5 tbsp) water. Stand for 3 minutes.		
Carrots	250 g	800 W	4½-5
	Instructions Cut carrots into even sized slices. Stand for 3 minutes.		
Cauliflower	250 g	800 W	5-5½
	500 g		8½-9
Instructions Prepare even sized florets. Cut big florets into halves. Arrange stems to the centre. Stand for 3 minutes.			
Courgettes	250 g	800 W	3½-4
	Instructions Cut courgettes into slices. Add 30 ml (2 tbsp) water or a knob of butter. Cook until just tender. Stand for 3 minutes.		
Egg Plants	250 g	800 W	3½-4
	Instructions Cut egg plants into small slices and sprinkle with 1 tbsp lemon juice. Stand for 3 minutes.		

Food	Serving Size	Power	Time (min.)
Leeks	250 g	800 W	4½-5
	Instructions Cut leeks into thick slices. Stand for 3 minutes.		
Mushrooms	125 g	800 W	1½-2
	250 g		3-3½
Instructions Prepare small whole or sliced mushrooms. Do not add any water. Sprinkle with lemon juice. Spice with salt and pepper. Drain before serving. Stand for 3 minutes.			
Onions	250 g	800 W	5½-6
	Instructions Cut onions into slices or halves. Add only 15 ml (1 tbsp) water. Stand for 3 minutes.		
Pepper	250 g	800 W	4½-5
	Instructions Cut pepper into small slices. Stand for 3 minutes.		
Potatoes	250 g	800 W	4-5
	500 g		7½-8½
Instructions Weigh the peeled potatoes and cut them into similar sized halves or quarters. Stand for 3 minutes.			
Turnip Cabbage	250 g	800 W	5-5½
	Instructions Cut turnip cabbage into small cubes. Stand for 3 minutes.		

REHEATING

Your microwave oven will reheat food in a fraction of the time that conventional ovens hobs normally take.

Use the power levels and reheating times in the following chart as a guide. The times in the chart consider liquids with a room temperature of about +18 to +20 °C or a chilled food with a temperature of about +5 to +7 °C.

Arranging and covering

Avoid reheating large items such as joint of meat – they tend to overcook and dry out before the centre is piping hot. Reheating small pieces will be more successful.

Power levels and stirring

Some foods can be reheated using 800 W power while others should be reheated using 600 W, 450 W or even 300 W.

Check the tables for guidance. In general, it is better to reheat food using a lower power level, if the food is delicate, in large quantities, or if it is likely to heat up very quickly (mince pies, for example).

Stir well or turn food over during reheating for best results. When possible, stir again before serving.

Take particular care when heating liquids and baby foods. To prevent eruptive boiling of liquids and possible scalding, stir before, during and after heating. Keep them in the microwave oven during standing time. We recommend putting a plastic spoon or glass stick into the liquids. Avoid overheating (and therefore spoiling) the food.

It is preferable to underestimate cooking time and add extra heating time, if necessary.

Heating and standing times

When reheating food for the first time, it is helpful to make a note of the time taken – for future reference.

Always make sure that the reheated food is piping hot throughout.

Allow food to stand for a short time after reheating - to let the temperature even out.

The recommended standing time after reheating is 2-4 minutes, unless another time is recommended in the chart.

Take particular care when heating liquids and baby food. See also the chapter with the safety precautions.

REHEATING LIQUIDS

Always allow a standing time of at least 20 seconds after the oven has been switched off to allow the temperature to even out. Stir during heating, if necessary, and ALWAYS stir after heating. To prevent eruptive boiling and possible scalding, you should put a spoon or glass stick into the beverages and stir before, during and after heating.

Reheating Liquids and Food

Use the power levels and times in this table as a guide lines for reheating.

Food	Serving Size	Power	Time (min.)
Drinks (Coffee, Tea and Water)	150 ml (1 cup)	800 W	1-1½
	250 ml (1 mug)		1½-2
Instructions Pour into cup and reheat uncovered. Put cup/ mug in the centre of turntable. Keep in microwave oven during standing time and stir well. Stand for 1-2 minutes.			
Soup (Chilled)	250 g	800 W	3-3½
	Instructions Pour into a deep ceramic plate. Cover with pierced cling film. Stir well after reheating. Stir again before serving. Stand for 2-3 minutes.		
Stew (Chilled)	350 g	600 W	5½-6½
	Instructions Put stew in a deep ceramic plate. Cover with pierced cling film. Stir occasionally during reheating and again before standing and serving. Stand for 2-3 minutes.		
Pasta with Sauce (Chilled)	350 g	600 W	4½-5½
	Instructions Put pasta (e.g. spaghetti or egg noodles) on a flat ceramic plate. Cover with microwave cling film. Stir before serving. Stand for 3 minutes.		
Filled Pasta with Sauce (Chilled)	350 g	600 W	5-6
	Instructions Put filled pasta (e.g. ravioli, tortellini) in a deep ceramic plate. Cover with plastic lid. Stir occasionally during reheating and again before standing and serving. Stand for 3 minutes.		
Plated Meal (Chilled)	350 g	600 W	5½-6½
	Instructions Plate a meal of 2-3 chilled components on a ceramic dish. Cover with microwave cling-film. Stand for 3 minutes.		

REHEATING BABY FOOD

BABY FOOD: Empty into a deep ceramic plate. Cover with plastic lid. Stir well after reheating!

Let stand for 2-3 minutes before serving. Stir again and check the temperature.

Recommended serving temperature: between 30-40 °C.

BABY MILK: Pour milk into a sterilised glass bottle. Reheat uncovered. Never heat a baby's bottle with teat on, as the bottle may explode if overheated. Shake well before standing time and again before serving ! Always carefully check the temperature of baby milk or food before giving it to the baby. Recommended serving temperature: ca. 37 °C.

REMARK:

Baby food particularly needs to be checked carefully before serving to prevent burns.

Use the power levels and times in the next table as a guide lines for reheating.

Reheating baby food and milk

Use the power levels and times in this table as guide lines for reheating.

Food	Serving Size	Power	Time
Baby Food (Vegetables + Meat)	190 g	600 W	30 sec.
	Instructions Empty into ceramic deep plate. Cook covered. Stir after cooking time. Before serving, stir well and check the temperature carefully. Stand for 2-3 minutes.		
Baby Porridge (Grain + Milk + Fruit)	190 g	600 W	20 sec.
	Instructions Empty into ceramic deep plate. Cook covered. Stir after cooking time. Before serving, stir well and check the temperature carefully. Stand for 2-3 minutes.		
Baby Milk	100 ml	300 W	30-40 sec.
	200 ml		50 sec. to 1 min.
Instructions Stir or shake well and pour into a sterilized glass bottle. Place into the centre of turn-table. Cook uncovered. Shake well and stand for at least 3 minutes. Before serving, shake well and check the temperature carefully. Stand for 2-3 minutes.			

MANUAL DEFROSTING

Microwaves are an excellent way of defrosting frozen food. Microwaves gently defrost frozen food in a short period of time. This can be of great advantage, if unexpected guests suddenly show up.

Frozen poultry must be thoroughly thawed before cooking. Remove any metal ties and take it out of any wrapping to allow thawed liquid to drain away.

Put the frozen food on a dish without cover. Turn over half way, drain off any liquid and remove any giblets as soon as possible.

Check the food occasionally to make sure that it does not feel warm.

If smaller and thinner parts of the frozen food start to warm up, they can be shield by wrapping very small strips of aluminium foil around them during defrosting.

Should poultry start to warm up on the outer surface, stop thawing and allow it to stand for 20 minutes before continuing.

Leave the fish, meat and poultry to stand in order to complete defrosting. The standing time for complete defrosting will vary depending on the quantity defrosted. Please refer to the table below.

Hint: Flat food defrosts better than thick and smaller quantities need less time than bigger ones. Remember this hint while freezing and defrosting food.

For defrosting of frozen food with a temperature of about -18 to -20 °C, use the following table as a guide.

Food	Serving Size	Power	Time (min.)
Meat			
Minced Beef	250 g 500 g	180 W	6½-7½ 10-12
Pork Steaks	250 g	180 W	7½-8½
	Instructions Place the meat on a flat ceramic plate. Shield thinner edges with aluminium foil. Turn over after half of defrosting time! Stand for 5-25 minutes.		

Food	Serving Size	Power	Time (min.)
Poultry			
Chicken Pieces	500 g (2 pcs)	180 W	14½-15½
Whole Chicken	900 g	180 W	28-30
	Instructions First, put chicken pieces first skin-side down, whole chicken first breast-side-down on a flat ceramic plate. Shield the thinner parts like wings and ends with aluminium foil. Turn over after half of defrosting time! Stand for 15-40 minutes.		
Fish			
Fish Fillets	250 g (2 pcs) 400 g (4 pcs)	180 W	6-7 12-13
	Instructions Put frozen fish in the middle of a flat ceramic plate. Arrange the thinner parts under the thicker parts. Shield narrow ends with aluminium foil. Turn over after half of defrosting time! Stand for 5-15 minutes.		
Fruits			
Berries	250 g	180 W	6-7
Instructions Distribute fruits on a flat, round glass dish (with a large diameter). Stand for 5-10 minutes.			
Bread			
Bread Rolls (Each about 50 g)	2 pcs 4 pcs	180 W	½-1 2-2½
	250 g	180 W	4½-5
German Bread (Wheat + Rye Flour)	500 g	180 W	8-10
Instructions Arrange rolls in a circle or bread horizontally on kitchen paper in the middle of turntable. Turn over after half of defrosting time! Stand for 5-20 minutes.			

GRILL

The grill-heating element is located underneath the ceiling of the cavity. It operates while the door is closed and the turntable is rotating. The turntable's rotation makes the food brown more evenly. Preheating the grill for 3-4 minutes will make the food brown more quickly.

Cookware for grilling:

Should be flameproof and may include metal. Do not use any type of plastic cookware, as it can melt.

Food suitable for grilling:

Chops, sausages, steaks, hamburgers, bacon and gammon rashers, thin fish portions, sandwiches and all kinds of toast with toppings.

Important remark:

Whenever the grill only mode is used, make sure that the grill-heating element is under the ceiling in the horizontal position and not on the back-wall in the vertical position. Please remember that food must be placed on the high rack, unless another instruction is recommended.

MICROWAVE + GRILL

This cooking mode combines the radiant heat that is coming from the grill with the speed of microwave cooking. It operates only while the door is closed and the turntable is rotating. Due to the rotation of the turntable, the food browns evenly. Three combination modes are available with this model: 600 W + Grill, 450 W + Grill and 300 W + Grill.

Cookware for cooking with microwave + grill

Please use cookware that microwaves can pass through. Cookware should be flameproof. Do not use metal cookware with combination mode. Do not use any type of plastic cookware, as it can melt.

Food suitable for microwave + grill cooking:

Food suitable for combination mode cooking include all kinds of cooked food which need reheating and browning (e.g. baked pasta), as well as foods which require a short cooking time to brown the top of the food. Also, this mode can be used for thick food portions that benefit from a browned and crispy top (e.g. chicken pieces, turning them over half way through cooking). Please refer to the grill table for further details.

Important remark:

Whenever the combination mode (microwave + grill) is used, make sure that the grill heating element is under the ceiling in the horizontal position and not on the back-wall in the vertical position. The food should be placed on the high rack, unless another instruction is recommended. Otherwise it has to be placed directly on the turntable. Please refer to the instructions in the following chart.

The food must be turned over, if it is to be browned on both sides.

Grill Guide for frozen food

Use the power levels and times in this table as guide lines for grilling.

Frozen Food	Serving Size	Power	1 step (min.)	2 step (min.)
Bread Rolls (Each ca. 50 g)	2 pcs	MW + Grill	300 W + Grill	Grill only
	4 pcs		1-1½	1-2
Instructions Arrange rolls in a circle on rack. Grill the second side of the rolls up to the crisp you prefer. Stand for 2-5 minutes.				
Baguettes + Topping (Tomatoes, Cheese, Ham, Mushrooms)	250-300 g (2 pcs)	450 W + Grill	8-9	-
	Instructions Put 2 frozen baguettes side by side on the rack. After grilling, Stand for 2-3 minutes.			
Gratin (Vegetables or Potatoes)	400 g	450 W + Grill	13-14	-
			Instructions Put frozen gratin into a small, round glass pyrex dish. Put the dish on the rack. After grilling. Stand for 2-3 minutes.	
Pasta (Cannelloni, Macaroni, Lasagne)	400 g	MW + Grill	300 W + Grill	Grill only
			18-19	1-2
Instructions Put frozen pasta into a small flat rectangular glass pyrex dish. Put the dish directly on the turntable. After grilling. Stand for 2-3 minutes.				
Chicken Nuggets	250 g	450 W + Grill	5-5½	3-3½
			Instructions Put chicken nuggets on the rack. Turn over after first time.	
Oven Chips	250 g	450 W + Grill	9-11	4-5
			Instructions Put oven chips evenly on baking paper on the rack.	

Grill Guide for fresh food

Preheat the grill with the grill-function for 3-4 minutes.

Use the power levels and times in this table as guide lines for grilling.

Fresh Food	Serving Size	Power	1 step (min.)	2 step (min.)
Toast Slices	4 pcs (each 25 g)	Grill only	6-8	4-5½
	Instructions Put the toast slices side by side on the rack.			
Bread Rolls (Already Baked)	2-4 pieces	Grill only	2-3	2-3
	Instructions Put bread rolls first with the bottom side up in a circle directly on the turntable.			
Grilled Tomatoes	200 g (2 pcs)	MW + Grill	300 W + Grill	Grill only
	400 g (4 pcs)		4½-5½	2-3
	Instructions Cut tomatoes into halves. Put some cheese on top. Arrange in a circle in a flat glass pyrex dish. Place it on the rack.			
Toast Hawaii (Ham, Pineapple, Cheese Slices)	2 pcs (300 g)	450 W + Grill	3½-4	-
	Instructions Toast the bread slices first. Put the toast with topping on the rack. Put 2 toasts opposite directly on the rack. Stand for 2-3 minutes.			
Baked Potatoes	250 g	600 W + Grill	4½-5½	-
	500 g		8-9	
Instructions Cut potatoes into halves. Put them in a circle on the rack with the cut side to the grill.				

Fresh Food	Serving Size	Power	1 step (min.)	2 step (min.)
Chicken Pieces	450-500 g (2 pcs)	300 W + Grill	10-12	12-13
	Instructions Prepare chicken pieces with oil and spices. Put them in a circle with the bones to the middle. Put 1 chicken piece not into the centre of the rack. Stand for 2-3 minutes.			
Lamb Chops/ Beef Steaks (Medium)	400 g (4 pcs)	Grill only	12-15	9-12
	Instructions Brush the lamb chops with oil and spices. Lay them in a circle on the rack. After grilling. Stand for 2-3 minutes.			
Pork Steaks	250 g (2 pcs)	MW + Grill	300 W + Grill	Grill only
			7-8	6-7
	Instructions Brush the pork steaks with oil and spices. Lay them in a circle on the rack. After grilling. Stand for 2-3 minutes.			
Baked Apples	1 apple (ca. 200 g)	300 W + Grill	4-4½	-
	2 apples (ca. 400 g)		6-7	
	Instructions Core the apples and fill them with raisins and jam. Put some almond slices on top. Put apples on a flat glass pyrex dish. Place the dish directly on the turntable.			
Roast Chicken	1200 g	MW + Grill	450 W + Grill	300 W + Grill
			22-24	23-25
Instructions Brush chicken with oil and spices. Put chicken first breast side down, second breast side up on pyrex dish. Stand for 5 minutes after grilling.				

TIPS AND TRICKS

MELTING BUTTER

Put 50 g butter into a small deep glass dish. Cover with plastic lid. Heat for 30-40 seconds using 800 W, until butter is melted.

MELTING CHOCOLATE

Put 100 g chocolate into a small deep glass dish. Heat for 3-5 minutes, using 450 W until chocolate is melted. Stir once or twice during melting. Use oven gloves while taking out!

MELTING CRYSTALLIZED HONEY

Put 20 g crystallized honey into a small deep glass dish. Heat for 20-30 seconds using 300 W until honey is melted.

MELTING GELATINE

Lay dry gelatine sheets (10 g) for 5 minutes into cold water. Put drained gelatine into a small glass pyrex bowl. Heat for 1 minute using 300 W. Stir after melting.

COOKING GLAZE/ICING (FOR CAKE AND GATEAUX)

Mix instant glaze (approximately 14 g) with 40 g sugar and 250 ml cold water. Cook uncovered in a glass pyrex bowl for 3½ to 4½ minutes using 800 W, until glaze/icing is transparent. Stir twice during cooking.

COOKING JAM

Put 600 g fruits (for example mixed berries) in a suitable sized glass pyrex bowl with lid. Add 300 g preserving sugar and stir well. Cook covered for 10-12 minutes using 800 W. Stir several times during cooking. Empty directly into small jam glasses with twist-off lids. Stand on lid for 5 minutes.

COOKING PUDDING

Mix pudding powder with sugar and milk (500 ml) by following the manufacturers instructions and stir well. Use a suitable sized glass pyrex bowl with lid. Cook covered for 6½ to 7½ minutes using 800 W. Stir several times well during cooking.

BROWNING ALMOND SLICES

Spread 30 g sliced almonds evenly on a medium sized ceramic plate. Stir several times during browning for 3½ to 4½ minutes using 600 W. Let it stand for 2-3 minutes in the oven. Use oven gloves while taking out!

troubleshooting and error code

TROUBLESHOOTING

If you have any of the problems listed below try the solutions given.

This is normal.

- Condensation inside the oven.
- Air flow around the door and outer casing.
- Light reflection around the door and outer casing.
- Steam escaping from around the door or vents.

The oven does not start when you press the START/+30s button.

- Is the door completely closed?

The food is not cooked at all.

- Have you set the timer correctly and/or pressed the **START/+30s** button?
- Is the door closed?
- Have you overloaded the electric circuit and caused a fuse to blow or a breaker to be triggered?

The food is either overcooked or undercooked.

- Was the appropriate cooking length set for the type of food?
- Was an appropriate power level chosen?

The light bulb is not working.

- The Light bulb should not be replaced in person for safety reasons. Please contact nearest authorised Samsung customer care, to arrange for a qualified engineer to replace the bulb.

The oven causes interference with radios or televisions.

- Slight interference may be observed on televisions or radios when the oven is operating. This is normal. To solve this problem, install the oven away from televisions, radios and aerials.
- If interference is detected by the oven's microprocessor, the display may be reset. To solve this problem, disconnect the power plug and reconnect it. Reset the time.

Sparking and cracking occur inside the oven (arcing).

- Have you used a dish with metal trimmings?
- Have you left a fork or other metal utensil inside the oven?
- Is aluminum foil too close to the inside walls?

Smoke and bad smell when initial operating.

- It's a temporary condition by new component heating. Smoke and smell will disappear completely after 10 minutes operation.
To remove smell more quickly, please operate microwave oven with putting lemon formation or lemon juice in the cabinet.

☑ If the above guidelines do not enable you to solve the problem, then contact your local SAMSUNG customer service centre.

Please have the following information read;

- The model and serial numbers, normally printed on the rear of the oven
- Your warranty details
- A clear description of the problem

Then contact your local dealer or SAMSUNG aftersales service.

ERROR CODE

"SE" message indicates.

- Clean the keys and check if there is water on the surface around key. Turn off the microwave oven and try setting again. If it occurs again, call your local SAMSUNG Customer Care Centre.

☑ For any codes not listed above, or if the suggested solution does not solve the problem, contact your local SAMSUNG Customer Care Centre.

technical specifications



SAMSUNG strives to improve its products at all times. Both the design specifications and these user instructions are thus subject to change without notice.

Model	GE83*KR*-1, GE83*KR*-2, GE83*KR*-3, GE83KR*-1, GE83KR*-2, GE83KR*-3, GE83KR*-1*, GE83KR*-2*, GE83KR*-3*, GE83MR**, GE83AR*
Power source	230 V ~ 50 Hz
Power consumption	
Microwave	1200 W
Grill	1100 W
Combined mode	2300 W
Output power	100 W / 800 W (IEC-705)
Operating frequency	2450 MHz
Magnetron	OM75P (31)
Cooling method	Cooling fan motor
Dimensions (W x H x D)	
Outside	489 x 275 x 372 mm (GE83KR*-1, GE83KR*-1*, GE83*KR*-1) 489 x 275 x 376 mm (GE83KR*-2, GE83KR*-2*, GE83*KR*-2) 489 x 275 x 370 mm (GE83KR*-3, GE83KR*-3*, GE83*KR*-3) 489 x 275 x 356 mm (GE83MR**) 489 x 275 x 380 mm (GE83AR*)
Oven cavity	330 x 211 x 324 mm
Volume	23 liter

Model	GE83*KR*-1, GE83*KR*-2, GE83*KR*-3, GE83KR*-1, GE83KR*-2, GE83KR*-3, GE83KR*-1*, GE83KR*-2*, GE83KR*-3*, GE83MR**, GE83AR*
Weight Net	12.5 kg approx (GE83*KR*-1, GE83*KR*-2, GE83*KR*-3, GE83KR*-1, GE83KR*-2, GE83KR*-3, GE83KR*-1*, GE83KR*-2*, GE83KR*-3*, GE83AR*) 13.0 kg approx (GE83M***)

※ **оборудование класса I**

Подлежит использованию по назначению
в нормальных условиях
Срок службы: 7 лет

	Символ «не для пищевой продукции» применяется в соответствии с техническим регламентом Таможенного союза «О безопасности упаковки» 005/2011 и указывает на то, что упаковка данного продукта не предназначена для повторного использования и подлежит утилизации. Упаковку данного продукта запрещается использовать для хранения пищевой продукции.
	Символ «петля Мебиуса» указывает на возможность утилизации упаковки. Символ может быть дополнен обозначением материала упаковки в виде цифрового и/или буквенного обозначения.



Производитель : Samsung Electronics Co., Ltd /
Самсунг Электроникс Ко., Лтд

Адрес производителя :
(Мэтан-донг) 129, Самсунг-ро, Йонгтонг-гу, Сувон-си,
Гيونгги-до, Корея, 443-742

Адрес мощностей производства :
ЛОТ 2, ЛЕБУХ 2, НОРС КЛАНГ СТРЕЙТС, ЭРИА 21,
ИНДАСТРИАЛ ПАРК, 42000
ПОРТ КЛАНГ, СЕЛАНГОР ДАРУЛ ЭСАН, МАЛАЙЗИЯ

Страна производства : Малайзия

Импортер в России :
ООО «Самсунг Электроникс Рус Компани»
Адрес: 125009, г. Москва, Россия, ул. Воздвиженка 10, 4 этаж

В СЛУЧАЕ ВОЗНИКНОВЕНИЯ ВОПРОСОВ ИЛИ КОММЕНТАРИЕВ

СТРАНА	ТЕЛЕФОН	ВЕБ-УЗЕЛ
RUSSIA	8-800-555-55-55	www.samsung.com/ru/support
GEORGIA	0-800-555-5555	www.samsung.com/support
ARMENIA	0-800-05-5555	
AZERBAIJAN	0-88-555-55-55	
KAZAKHSTAN	8-10-800-500-55-500(GSM: 7799, VIP care 7700)	
UZBEKISTAN	8-10-800-500-55-500	www.samsung.com/kz_ru/support
KYRGYZSTAN	8-10-800-500-55-500	
TADJIKISTAN	8-10-800-500-55-500	www.samsung.com/support
MONGOLIA	7-495-363-17-00	
BELARUS	810-800-500-55-500	
MOLDOVA	0-800-614-40	
UKRAINE	0-800-502-000	
		www.samsung.com/ua/support (Ukrainian) www.samsung.com/ua_ru/support (Russian)