

**lenovo**

# Lenovo ideapad 100-14IBY/ 100-15IBY User Guide



Read the safety notices and important tips in the included manuals before using your computer.

ideapad

## Notes

- Before using the product, be sure to read *Lenovo Safety and General Information Guide* first.
- Some instructions in this guide may assume that you are using Windows® 8.1. If you are using another Windows operating system, some operations may be slightly different. If you are using other operating systems, some operations may not apply to you.
- The features described in this guide are common to most models. Some features may not be available on your computer or your computer may include features that are not described in this user guide.
- The illustrations used in this manual are for Lenovo ideapad 100-15IBY unless otherwise stated.
- The illustrations in this manual may differ from the actual product. Please refer to the actual product.

## Regulatory Notice

- For details, refer to **Guides & Manuals** at <http://support.lenovo.com>.

**First Edition (March 2015)**

**© Copyright Lenovo 2015.**

LIMITED AND RESTRICTED RIGHTS NOTICE: If data or software is delivered pursuant to a General Services Administration "GSA" contract, use, reproduction, or disclosure is subject to restrictions set forth in Contract No. GS-35F-05925.

# Contents

<b>Chapter 1. Getting to know your computer.....</b>	<b>1</b>
Top view.....	1
Left-side view.....	7
Right-side view.....	10
Front view.....	11
Bottom view.....	13
<b>Chapter 2. Starting to use Windows 8.1 .....</b>	<b>15</b>
Configuring the operating system for the first time.....	15
Operating system interfaces.....	15
The charms.....	16
Putting the computer to sleep or shutting it down.....	18
Connecting to a wireless network.....	20
Help and support.....	21
<b>Chapter 3. Lenovo OneKey Recovery System.....</b>	<b>22</b>
<b>Chapter 4. Troubleshooting.....</b>	<b>23</b>
Frequently asked questions.....	23
Troubleshooting.....	25
<b>Appendix A. CRU instructions .....</b>	<b>29</b>
Removing the keyboard.....	29
Removing the optical drive (Lenovo ideapad 100-15IBY).....	32
<b>Trademarks .....</b>	<b>34</b>



# Chapter 1. Getting to know your computer

## ■ ■ Top view

---

### ■ Lenovo ideapad 100-14IBY

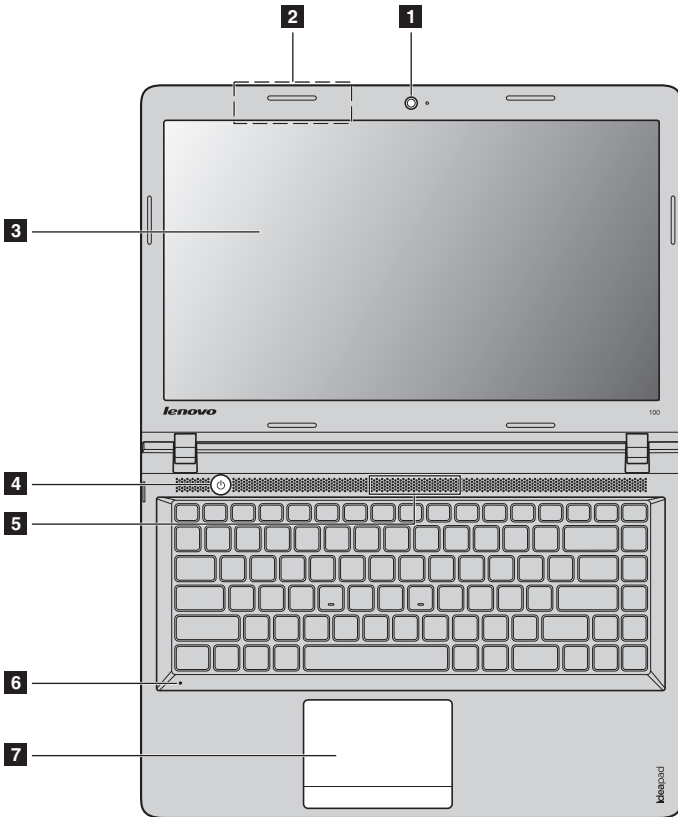

## Chapter 1. Getting to know your computer

### ■ Lenovo ideapad 100-15IBY

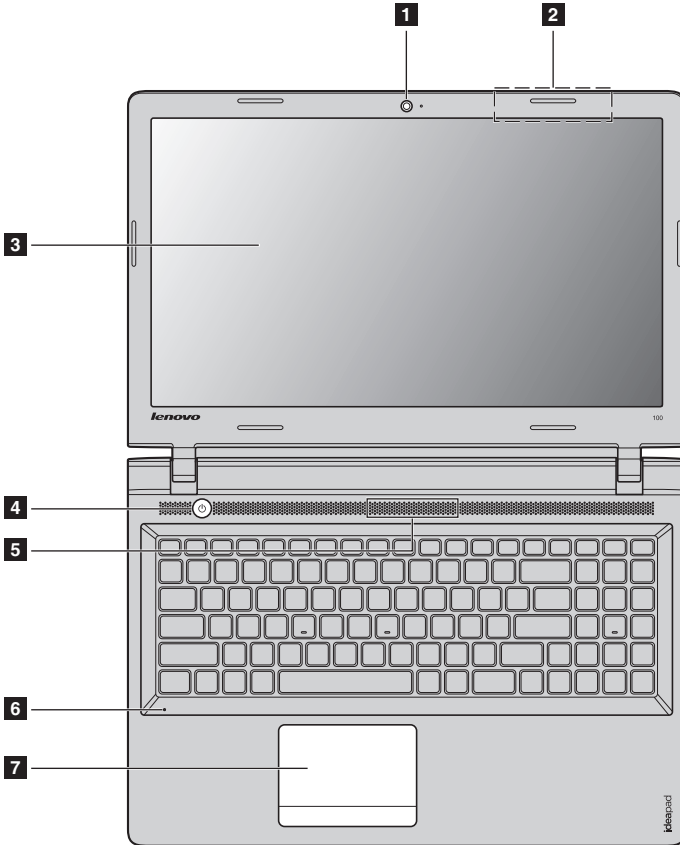

**Note:** The dashed areas indicate parts that are not visible externally.

#### ⊙ Attention:

- When closing the display panel, be careful *not* to leave pens or any other objects in between the display panel and the keyboard. Otherwise, the display panel may be damaged.

- 1 Integrated camera** Use the camera for video communication.
- 2 Wireless LAN antennas** Connect to a wireless LAN adapter to send and receive wireless radio signals.
- 3 Computer display** Provides brilliant visual output.
- 4 Power button** Press this button to turn on the computer.
- 5 Speaker** Provides audio output.
- 6 Built-in microphone** Captures sound which can be used for video conferencing, voice narration, or audio recording.
- 7 Touchpad** The touchpad functions as a conventional mouse.  
**Touchpad:** To move the pointer on the screen, slide your fingertip over the pad in the direction in which you want the pointer to move.  
**Touchpad buttons:** The functions of the left/right side correspond to that of the left/right mouse button on a conventional mouse.

**Note:** You can enable/disable the touchpad by pressing **F6** ()

## Chapter 1. Getting to know your computer

### ■ Using the keyboard

#### Numeric keypad (Lenovo ideapad 100-15IBY)

The keyboard has a separate numeric keypad. To enable or disable the numeric keypad, press **Fn + Delete**.

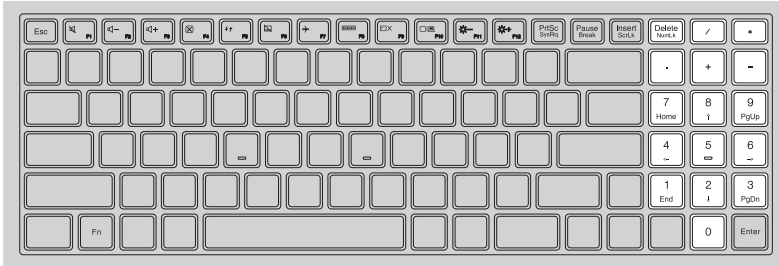

#### Function key combinations

Through the use of the function keys, you can change operational features instantly. To use this function, press and hold **Fn 1**; then press one of the function keys **2**.

#### Lenovo ideapad 100-14IBY

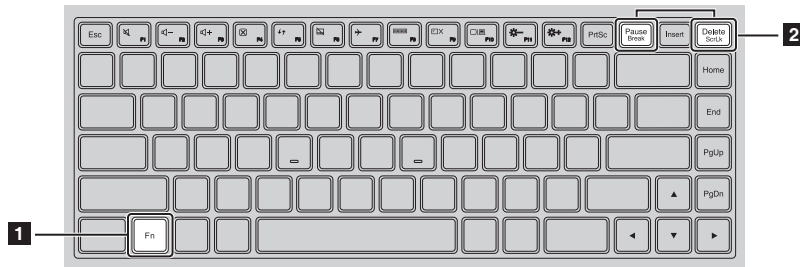



## Lenovo ideapad 100-151BY

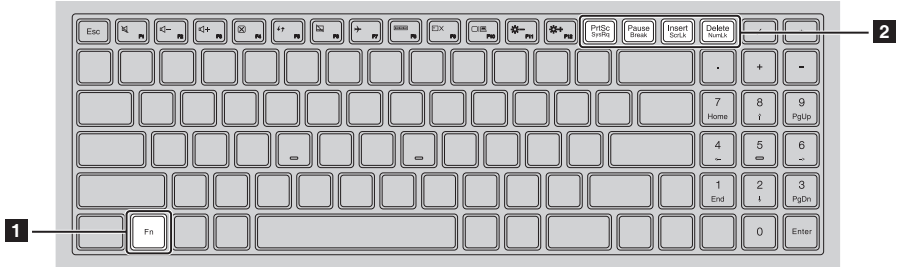

The following describes the features of each function key.

**Fn + PrtSc (ideapad 100-151BY):** Activates the system request.

**Fn + Pause:** Activates the break function.

**Fn + Delete (ideapad 100-141BY):** Enables/disables the scroll lock.

**Fn + Insert (ideapad 100-151BY):**

**Fn + Delete (ideapad 100-151BY):** Enables/disables the numeric keypad.

## Hotkeys

You can access certain system settings quickly by pressing the appropriate hotkeys.

## Lenovo ideapad 100-141BY

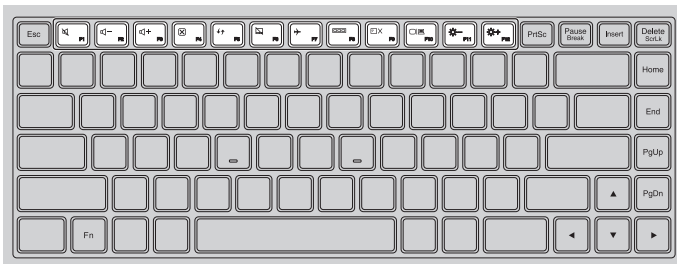

## Chapter 1. Getting to know your computer

### Lenovo ideapad 100-15IBY

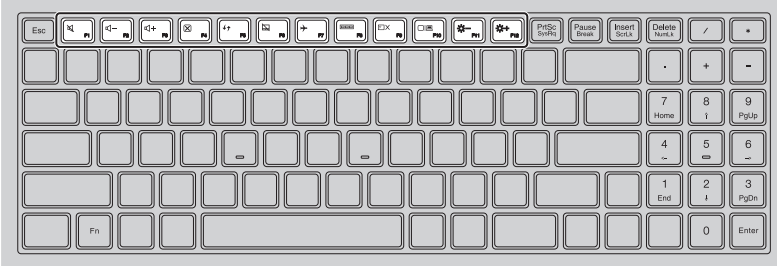

: Mutes/unmutes the sound.



: Enables/disables Airplane mode.



: Decreases the volume level.



: Displays all currently active apps.



: Increases the volume level.



: Turns on/off the backlight of the LCD screen.



: Closes the currently active window.



: Toggles the display between the computer and an external device.



: Refreshes the desktop or the currently active window.



: Decreases the display brightness.



: Enables/disables the touchpad.



: Increases the display brightness.

### Setting hotkey mode

By default, the hotkey functions are accessible by pressing the appropriate hotkey. However, you can disable the hotkey mode in the BIOS setup utility.

To disable the hotkey mode:

- 1 Shut down the computer.
- 2 Press the Novo button and then select **BIOS Setup**.
- 3 In the BIOS setup utility, open the **Configuration** menu, and change the setting of **HotKey Mode** from **Enabled** to **Disabled**.
- 4 Open the **Exit** menu, and select **Exit Saving Changes**.

**Note:** When hotkey mode is disabled, press the **Fn** key and the appropriate hotkey to access the corresponding hotkey function.

## ■ ■ Left-side view

### ■ Lenovo ideapad 100-14IBY

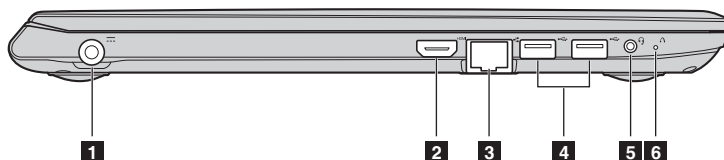

### ■ Lenovo ideapad 100-15IBY

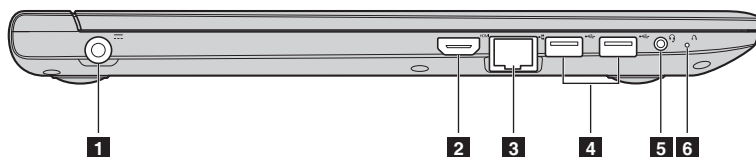

- 1 AC power adapter jack** Connects to the AC power adapter.
- 2 HDMI port** Connects to devices with HDMI input such as a TV or an external display.
- 3 RJ-45 port** Connects the computer to an Ethernet network.

**Note:** For details, see “Connecting network cables” on page 8.

- 4 USB port** Connects to USB devices.

**Note:** For details, see “Connecting USB device” on page 9.

- 5 Combo audio jack** Connects to headsets.

**Notes:**

- The combo audio jack does not support conventional microphones.
- The recording function might not be supported if third-party headphones or headsets are connected, due to different industry standards.

- 6 Novo button** When the computer is off, press this button to start the Lenovo OneKey Recovery System or the BIOS setup utility, or to enter the boot menu.

**Notes:**

- You can use the tip of an unfolded paper clip (or similar object without a sharp tip) to gently press the Novo button.
- For details, see “Lenovo OneKey Recovery System” on page 22.

## Chapter 1. Getting to know your computer

### ■ Connecting network cables

Wired connections are a reliable and safe way to connect the computer to the Internet. You can connect a network cable to your computer.

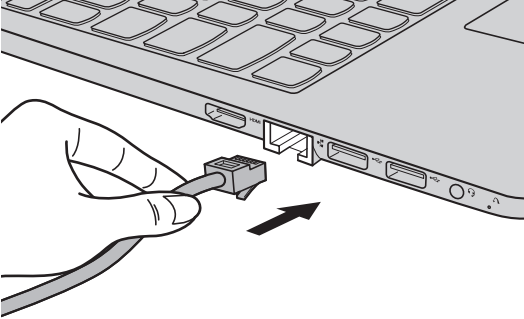

### Software configuration

Consult your Internet Service Provider (ISP) for details on how to configure your computer.

### ■ Connecting USB device

Your computer comes with two USB ports compatible with USB devices.

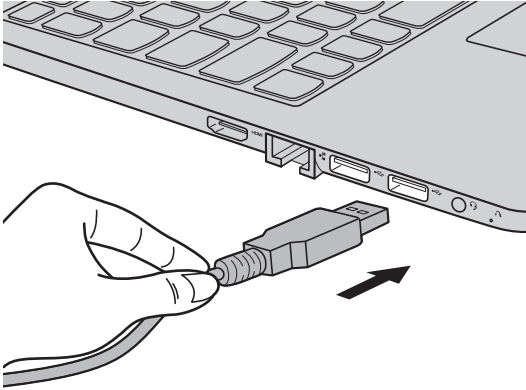

The first time you plug a USB device into a particular USB port on your computer, Windows automatically installs a driver for that device. After the driver has been installed, you can disconnect and reconnect the device without performing any additional steps.

**Note:** Typically, Windows detects a new device after it has been connected, and then installs the driver automatically. However, some devices may require you to install the driver before connecting. Check the documentation provided by the device's manufacturer before connecting the device.

Before disconnecting a USB storage device, make sure your computer has finished transferring data to that device. Click the **Safely Remove Hardware and Eject Media** icon in the Windows notification area to remove the device before disconnecting.

**Note:** If your USB device uses a power cord, connect the device to a power source before connecting it. Otherwise, the device may not be recognized.

## Right-side view

### Lenovo ideapad 100-14IBY



### Lenovo ideapad 100-15IBY

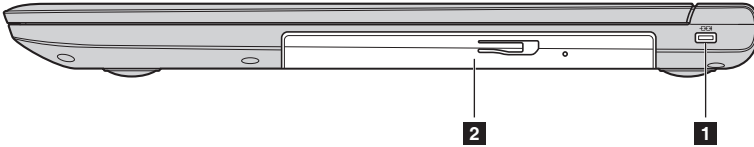

#### 1 Kensington lock slot

Attach a security lock (not supplied) here to help protect your computer from theft and unauthorized use. You can attach a security lock to your computer to help prevent it from being removed without your permission. For details on installing the security lock, please refer to the instructions shipped with the security lock that you have purchased.

#### Notes:

- Before purchasing any security product, verify that it is compatible with this type of security keyhole.
- You are responsible for evaluating, selecting, and implementing the locking devices and security features. Lenovo offers no comment, judgment, or warranty regarding the function, quality, or performance of locking devices and security features.

#### 2 Optical drive (on select models)

Reads/burns optical discs.

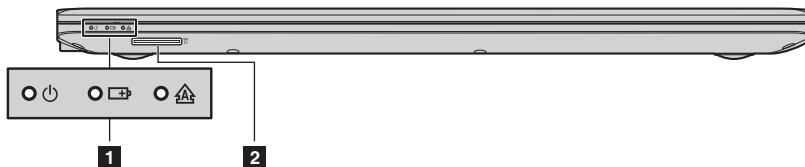

## ■ ■ Front view



### 1 System status indicators

### 2 Memory card slot Accepts memory cards (not supplied).

**Note:** For details, see “Using memory cards (not supplied)” on page 12.

Symbol	Indicator	Indicator status	Charge status	Meaning
	Power	On (solid white)	---	The computer is powered on.
		Blinking	---	The computer is in sleep mode.
		Off	---	The computer is powered off.
	Battery	On (solid white)	Charging	The battery has more than 80% charge.
		On (solid white)	Discharging	The battery has more than 20% charge.
		On (solid amber)	Discharging	The battery has between 5% and 20% charge.
		Blinking slowly (white)	Charging	The battery has between 20% and 80% charge. When the battery reaches 80% charge, the light will stop blinking. However, charging will continue until the battery is fully charged.
		Blinking slowly (amber)	Charging	The battery has less than 20% charge. When the battery charge reaches 20%, the blinking color will change to white.
		Blinking quickly (amber)	Charging/Discharging	The battery has less than 5% charge.
	Caps lock	On (solid white)	---	Uppercase input mode is enabled. (All typed letters are uppercase by default.)
		Off	---	Uppercase input mode is disabled.

## Chapter 1. Getting to know your computer

### ■ Using memory cards (not supplied)

Your computer supports the following types of memory cards:

- Secure Digital (SD) card
- Secure Digital High Capacity (SDHC) card
- Secure Digital eXtended Capacity (SDXC) card
- MultiMediaCard (MMC)

**Notes:**

- Insert *only* one card in the slot at a time.
- This card reader does not support SDIO devices (e.g., SDIO Bluetooth, etc.).

### Inserting a memory card

Insert the memory card until it touches the bottom of the slot.

### Removing a memory card

Gently pull the memory card out of the memory card slot.

**Note:** Before removing the memory card, disable it by using the Windows safely remove hardware and eject media utility to avoid data corruption.



■ ■ Bottom view

---

■ Lenovo ideapad 100-14IBY

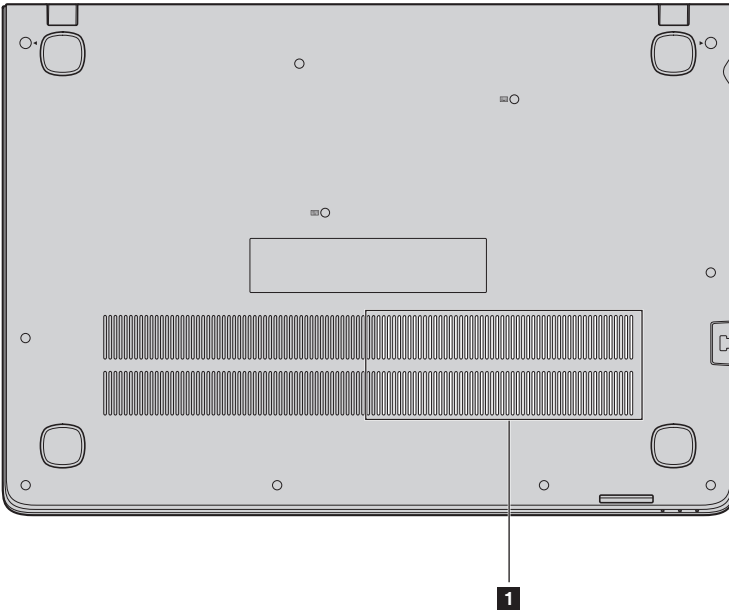

## Chapter 1. Getting to know your computer

### ■ Lenovo ideapad 100-15IBY

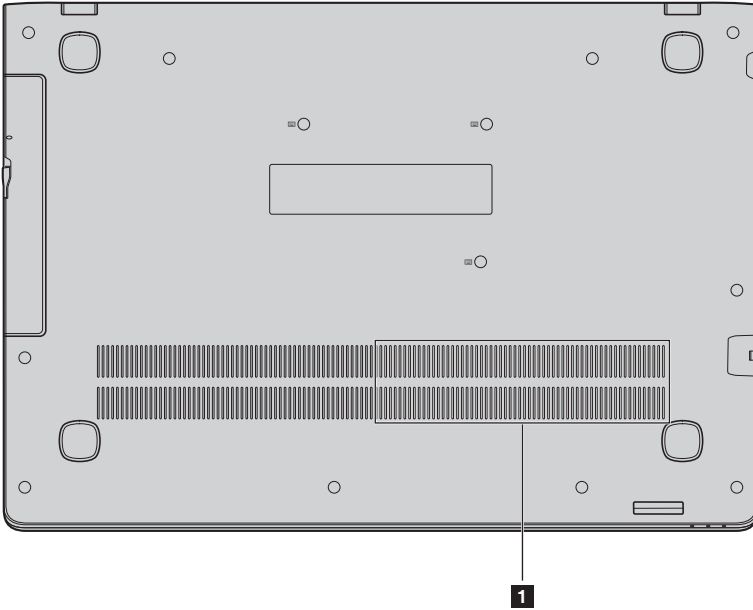

**1** **Ventilation slots** Dissipate internal heat.

**Note:** Make sure that the ventilation slots are not blocked or else the computer may overheat.

## Chapter 2. Starting to use Windows 8.1

### ■ ■ Configuring the operating system for the first time

---

You may need to configure the operating system when it is first used. The configuration process may include the procedures below:

- Accepting the end user license agreement
- Configuring the Internet connection
- Registering the operating system
- Creating a user account

### ■ ■ Operating system interfaces

---

Windows 8.1 comes with two main user interfaces: the Start screen and the Windows desktop. To switch from the Start screen to the Windows desktop, do one of the following:

- Select the Windows desktop tile on the Start screen.
- Press the Windows key  + D.

To switch from the desktop to the Start screen, do one of the following:

- Select **Start**  from the charms bar.
- Move the cursor to the lower-left corner, and then select the **Start** button.

#### Start screen

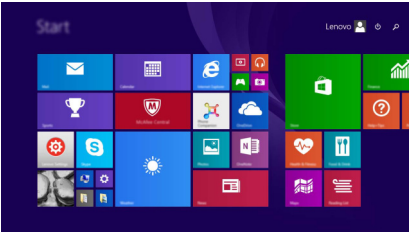

#### Desktop

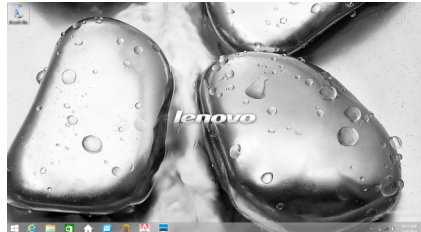

## ■ ■ The charms

**Charms** are navigation buttons that let you control your Windows® 8.1 experience. Charms include: Search, Share, Start, Devices, and Settings. The **Charms Bar** is the menu that contains the charms.

The five charms provide new and faster ways to perform many basic tasks, and are always available regardless of whichever app you are currently in.

To display the charms, do one of the following:

- Move the cursor to the upper-right or lower-right corner until the charms bar is displayed.
- Use one finger to swipe in from the right edge of the screen until the charms bar is displayed.
- Press Windows key  + C.

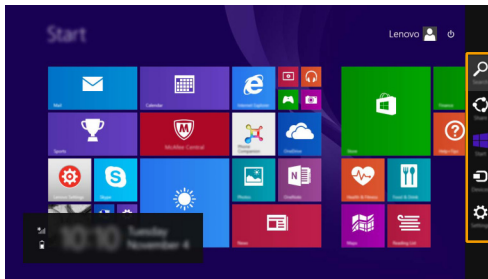

### Search charm

The **Search** charm is a powerful new way to find what you are looking for, including settings, files, Web images, Web videos, etc.

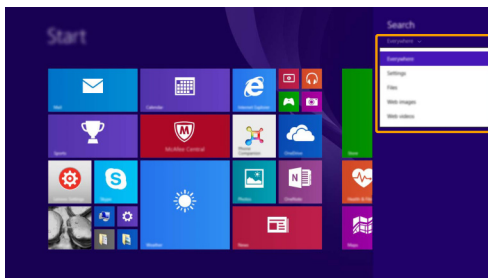

### Share charm

The **Share** charm lets you send links, photos, and more to your friends and social networks without leaving the app you are in.

### **Start charm**

The **Start** charm is a fast way to go to the Start screen.

### **Devices charm**

The **Devices** charm allows you to connect or send files to any external devices, including the devices to play, print, and project.

### **Settings charm**

The **Settings** charm lets you perform basic tasks, such as setting the volume or shutting down the computer. Also, you can get to the Control Panel through the **Settings** charm when on the Desktop screen.

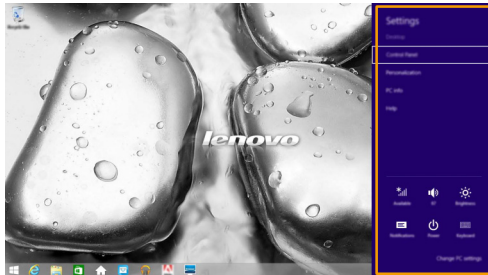

### ■ ■ Putting the computer to sleep or shutting it down

When you have finished working with your computer, you can put it to sleep or shut it down.

#### ■ Putting your computer to sleep

If you will be away from your computer for only a short time, put the computer to sleep. When the computer is in sleep mode, you can quickly wake it to resume use, bypassing the startup process.

To put the computer to sleep, do one of the following:

- Close the display lid.
- Press the Power button.
- Open the charms, and then select **Settings**  → **Power**  → **Sleep**.

**Note:** Wait until the power indicator light starts blinking (indicating that the computer is in sleep mode) before you move your computer. Moving your computer while the hard disk is spinning can damage the hard disk, causing loss of data.

To wake the computer, do one of the following:

- Press any key on the keyboard. (Notebook mode only)
- Press the Power button.

### ■ Shutting down the computer

If you are not going to use your computer for a long time, shut it down. To shut down the computer, do one of the following:

- Open the charms, and then select **Settings**  → **Power**  → **Shut down**.

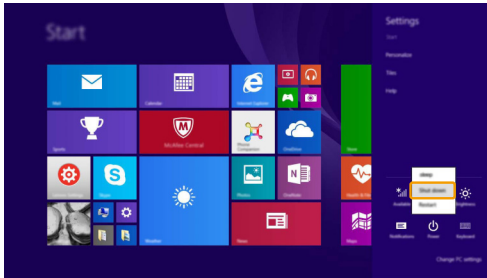

- Right-click the **Start** button in the lower-left corner and select **Shut down or sign out** → **Shut down**.



- Select  → **Shut down** in the upper-right corner of the Start screen.

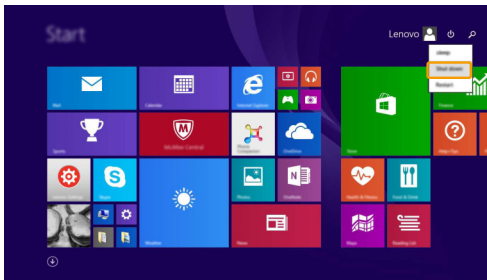



**Note:** The operation depends on the BIOS setup. Please refer to the actual product.

## ■ ■ Connecting to a wireless network

### Enabling wireless connection

To enable wireless functions, do one of the following:

- Press F7 (  ) to disable airplane mode.
- Open the charms and select **Settings**  →  to open the network configuration page. Then toggle the airplane mode switch to **off**.

**Note:** Ensure the Wi-Fi switch on the Network configuration page is toggled to **On**.

### Connecting to a wireless network

After wireless has been enabled, the computer will automatically scan for available wireless networks and display them in the wireless network list. To connect to a wireless network, click the network name in the list, and then click **Connect**.

**Note:** Some networks require a network security key or passphrase for connection. To connect to one of those networks, ask the network administrator or the Internet service provider (ISP) for the security key or passphrase.

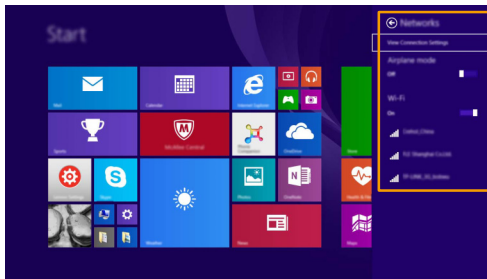



## ■ ■ Help and support

---

If you have a problem with the operating system, see the Windows Help and Support file. To open the Windows Help and Support file, do one of the following:

- Select **Settings** charm, then select **Help**.
- Press Windows key  + **Fn + F1**.

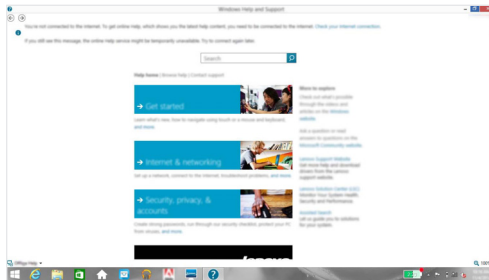

You can read the Windows Help and Support file on your computer. You can also get online help and support by clicking on one of the two links listed under **More to explore**.

**Note:** Windows 8.1 also provides an app, **Help + Tips**. You can find it on the Start screen, to learn more information on new features of Windows 8.1.

## Chapter 3. Lenovo OneKey Recovery System

The Lenovo OneKey Recovery System is software designed to back up and restore your computer. You can use it to restore the system partition to its original status in case of a system failure. You can also create user backups for easy restoration as required.

### Notes:

- If your computer is preinstalled with a GNU/Linux operating system, OneKey Recovery System is not available.
- To utilize the features of the OneKey Recovery System, your hard disk already includes a hidden partition by default to store the system image file and the OneKey Recovery System program files. This default partition is hidden for security reasons, which explains why the available disk space is less than the stated capacity.

### ■ Backing up the system partition

You can back up the system partition to an image file. This image file can be used to restore the system partition. To back up the system partition:

- ❶ In Windows, press the Novo button or double-click OneKey Recovery icon to start the Lenovo OneKey Recovery System.
- ❷ Click **System Backup**.
- ❸ Select a back-up location and click **Next** to start the backup.

### Notes:

- You can choose a back-up location on the local hard disk drive or an external storage device.
- Remove the removable hard disk drive before starting the Lenovo OneKey Recovery System. Otherwise, data from the removable hard disk drive might be lost.
- The back-up process may take a while.
- The back-up process is only available when Windows can be started normally.

### ■ Restoring

You can choose to restore the system partition to its original status or to a previously created back-up point. To restore the system partition:

- ❶ In Windows, press the Novo button or double-click OneKey Recovery icon to start the Lenovo OneKey Recovery System.
- ❷ Click **System Recovery**. The computer will restart to the recovery environment.
- ❸ Follow the on-screen instructions to restore the system partition to its original status or to a previously created back-up point.

### Notes:

- The recovery process is irreversible. Make sure to back up any data you wish to save on the system partition before starting the recovery process.
- The recovery process may take a while. So be sure to connect the AC power adapter to your computer during the recovery process.
- The above instructions should be followed when Windows can be started normally.

If Windows cannot be started, then follow the steps below to start the Lenovo OneKey Recovery System:

- ❶ Shut down the computer.
- ❷ Press the Novo button. From **Novo Button Menu**, select **System Recovery** and press Enter.

# Chapter 4. Troubleshooting

## ■ ■ Frequently asked questions

---

This section lists frequently asked questions by category.

### ■ Finding information

#### **What safety precautions should I follow when using my computer?**

The Lenovo *Safety and General Information Guide* which came with your computer contains safety precautions for using your computer. Read and follow all the precautions when using your computer.

#### **Where can I find the hardware specifications for my computer?**

You can find the hardware specification for your computer on the printed flyers which came with your computer.

#### **Where can I find warranty information?**

For detailed warranty information on this machine, please visit below website to check out: [support.lenovo.com/warrantystatus](http://support.lenovo.com/warrantystatus).

### ■ Drivers and preinstalled software

#### **Where are the installation discs for Lenovo preinstalled software (desktop software)?**

Your computer did not come with installation discs for Lenovo preinstalled software. If you need to reinstall any preinstalled software, you can find the installation program on the D partition of your hard disk. If you cannot find the installation program there, you can also download it from the Lenovo consumer support website.

#### **Where can I find drivers for the various hardware devices of my computer?**

If your computer is preinstalled with a Windows operating system, Lenovo provides drivers for all the hardware devices that you need on the D partition of your hard disk. You can also download the latest device drivers from the Lenovo consumer support website.

### ■ Lenovo OneKey Recovery System

#### **Where are the recovery discs?**

Your computer did not come with any recovery discs. Use the Lenovo OneKey Recovery System if you need to restore the system to its original factory status.

#### **What can I do if the back-up process fails?**

If you can start the backup but it fails during the back-up process, try the following steps:

- 1 Close all open programs, and then restart the back-up process.
- 2 Check to see if the destination media is damaged. Select another path and then try again.

#### **When do I need to restore the system to its factory status?**

Use this feature when the operating system fails to start up. If there is critical data on the system partition, back it up before starting recovery.

## Chapter 4. Troubleshooting

### ■ BIOS setup utility

#### What is the BIOS setup utility?

The BIOS setup utility is a ROM-based software. It displays basic computer information and provides options for setting boot devices, security, hardware mode, and other preferences.

#### How can I start the BIOS setup utility?

To start the BIOS setup utility:

- ❶ Shut down the computer.
- ❷ Press the Novo button and then select **BIOS Setup**.

#### How can I change the boot mode?

There are two boot modes: **UEFI** and **Legacy Support**. To change the boot mode, start the BIOS setup utility and set boot mode to **UEFI** or **Legacy Support** on the boot menu.

#### When do I need to change the boot mode?

The default boot mode for your computer is **UEFI** mode. If you need to install a legacy operating system, such as Windows, Linux or Dos, etc. (that is, any operating system before Windows 8) on your computer, you must change the boot mode to **Legacy Support**. The legacy operating system, such as Windows, Linux or Dos, etc. cannot be installed if you don't change the boot mode.

### ■ Getting help

#### How can I contact the customer support center?

See “Chapter 3. Getting help and service” in the *Lenovo Safety and General Information Guide*.

## ■ ■ Troubleshooting

### Display problems

When I turn on the computer, nothing appears on the screen.

- If the screen is blank, make sure that:
  - The AC power adapter is connected to the computer, and plugged into a working electrical outlet.
  - The computer power is on. (Press the Power button again for confirmation.)
- If these items are properly set, and the screen remains blank, have the computer serviced.

When I turn on the computer, only a white cursor appears on a blank screen.

- Restore backed-up files to your Windows environment or the entire contents of your hard disk to its original factory contents using the Lenovo OneKey Recovery System. If you still see only the cursor on the screen, have the computer serviced.

The screen goes blank while the computer is on.

- Your screen saver or power management may be enabled. Do one of the following to exit from the screen saver or to resume from sleep mode:
  - Touch the touchpad.
  - Press any key on the keyboard.
  - Press the Power button.
- Press **F9** (  ) to confirm whether the backlight of the LCD screen has been turned off.

### BIOS password problems

I forgot my password.

- If you forget your user password, ask the system administrator to clear your user password.
- If you forget your hard disk drive password, a Lenovo authorized servicer cannot reset your password or recover data from the hard disk. You must take your computer to a Lenovo authorized servicer or a marketing representative to have the hard disk drive replaced. Proof of purchase is required, and a fee will be charged for parts and service.
- If you forget your administrator password, a Lenovo authorized servicer cannot reset your password. You must take your computer to a Lenovo authorized servicer or a marketing representative to have the system board replaced. Proof of purchase is required, and a fee will be charged for parts and service.

## Chapter 4. Troubleshooting

### Sleep problems

The critical low-battery error message appears, and the computer immediately turns off.

- The battery power is getting low. Connect the AC power adapter to the computer.

The computer enters sleep mode immediately after Power-on self-test (POST).

- Make sure that:
  - The battery pack is charged.
  - The operating temperature is within the acceptable range. See “Chapter 2. Use and care Information” in the *Lenovo Safety and General Information Guide*.



**Note:** If the battery pack is charged and the temperature is within range, have the computer serviced.

The computer does not return from sleep mode, and the computer does not work.

- If your computer is in sleep mode, connect the AC power adapter to the computer, then press any key or the Power button.
- If the system still does not return from sleep mode, stops responding, or cannot be turned off, reset the computer. Unsaved data may be lost. To reset the computer, press and hold the Power button for four seconds or more. If the computer is still not reset, remove the AC power adapter.

### Display panel problems

The screen is blank.

- Do the following:
  - If you are using the AC power adapter or the battery pack, and the battery status indicator is on, press **F12** (  ) to make the screen brighter.
  - If the power indicator is blinking, press the Power button to resume from sleep mode.
  - If the problem persists, follow the solution in the next problem “The screen is unreadable or distorted.”
  - Press **F9** (  ) to confirm whether the backlight of the LCD screen has been turned off.

The screen is unreadable or distorted.

- Make sure that:
  - The display device driver is installed correctly.
  - The screen resolution and color quality are correctly set.
  - The monitor type is correct.

Incorrect characters appear on the screen.

- Are the operating system or programs installed correctly? If they are installed and configured correctly, have the computer serviced.

### Sound problems

No sound can be heard from the speaker even when the volume is turned up.

- Make sure that:
  - The Mute function is off.
  - The combo audio jack is not being used.
  - Speakers are selected as the playback device.

### Battery pack problems

Your computer shuts down before the battery status indicator shows empty.

-or-

Your computer operates after the battery status indicator shows empty.

The computer does not operate with a fully charged battery pack.

- Discharge and recharge the battery pack.
- The surge protector in the battery pack might be active. Turn off the computer for one minute to reset the protector; then turn on the computer again.

### A hard disk drive problem

The hard disk drive does not work.

- Make sure that the hard disk drive is included in the **Boot** menu in the BIOS setup utility correctly.

### OneKey Recovery System problems

Backup cannot be made.

- Make sure that you are currently using a Windows operating system.
- There may not be enough space to store the backed-up data. You will need to free more hard disk space on your backup's partition.

Failure to restore system partition to factory default.

- The system partition (e.g. the partition size or the drive capacity of C) has been modified.

### Other problems

Your computer does not respond.

- To turn off your computer, press and hold the Power button for four seconds or more. If the computer still does not respond, remove the AC power adapter.
- Your computer might lock when it enters sleep mode during a communication operation. Disable the sleep timer when you are working on the network.

The computer does not start from a device you want.

- See the **Boot** menu of the BIOS setup utility. Make sure that the BIOS setup utility is set so that the computer starts from the device you want.
- Also make sure that the device from which the computer starts is enabled. Make sure that the device is included in the **Boot** menu in the BIOS setup utility correctly.
- While turned off, press the Novo button to select the device you want the computer to start from.

The connected external device does not work.

- Do *not* connect or disconnect any external device cables other than USB while the computer power is on. Otherwise, you might damage your computer.
- When using high power consumption external devices such as an external USB optical disk drive, use an external device power adapter. Otherwise, the device may not be recognized, or the system may shut down as a result.



# Appendix A. CRU instructions

## ■ ■ Removing the keyboard

---

To remove the keyboard, do the following:

- ❶ Turn off the computer. Disconnect the AC power adapter and all cables from the computer.
- ❷ Close the computer display, and then turn the computer over.
- ❸ Remove the screws that secure the keyboard **❶**.

### Lenovo ideapad 100-14IBY

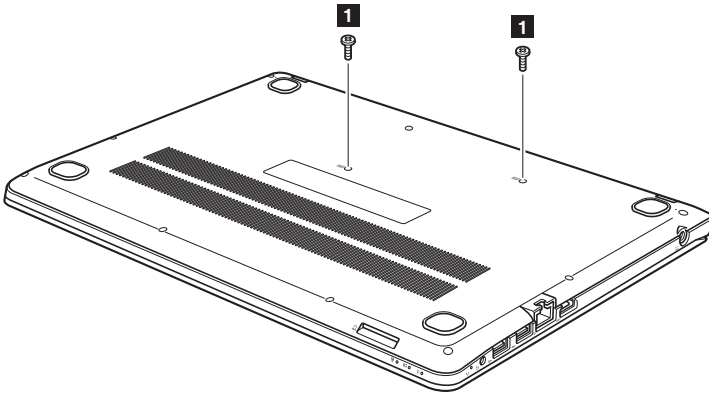

### Lenovo ideapad 100-15IBY

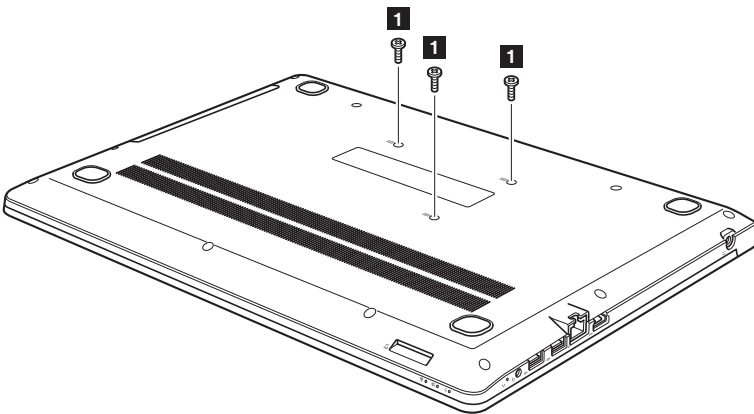

- ❹ Turn the computer over, and then open the computer display.
- ❺ Push the keyboard with the tip of an unfolded paper clip (or similar object without a sharp tip) through the screw hole on the back cover.

## Appendix A. CRU instructions

- Loosen the keyboard with fingers **2**, and then lift the keyboard slightly **3**.

### Lenovo ideapad 100-14IBY

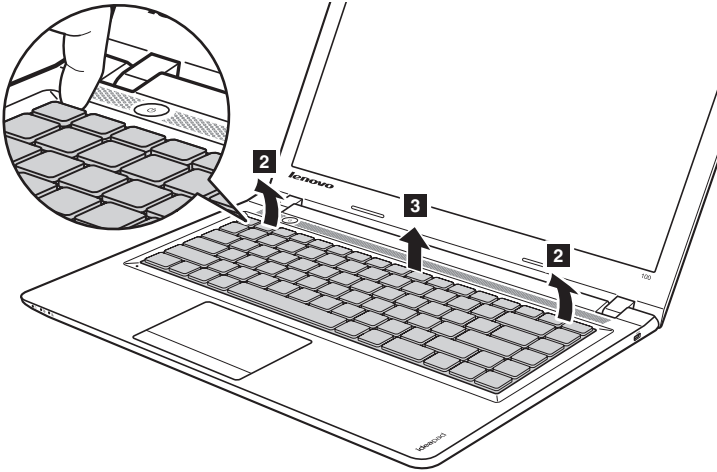

### Lenovo ideapad 100-15IBY

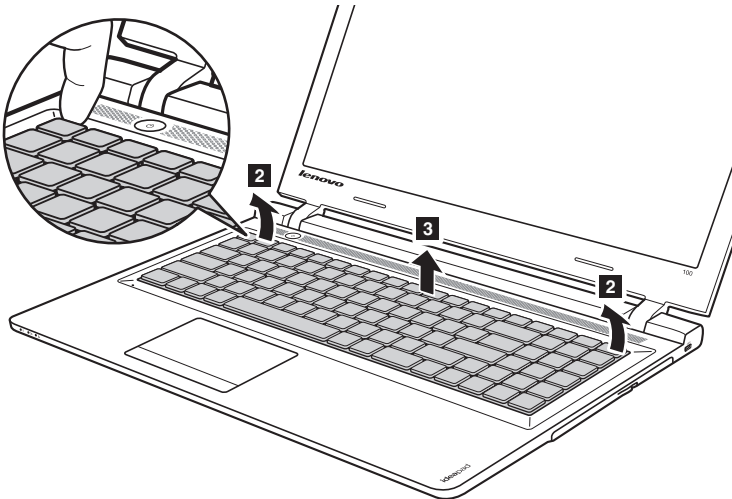

- 7 Disconnect the keyboard connector in the direction shown by arrows **4** and **5**. Then remove the keyboard.

**Lenovo ideapad 100-14IBY**

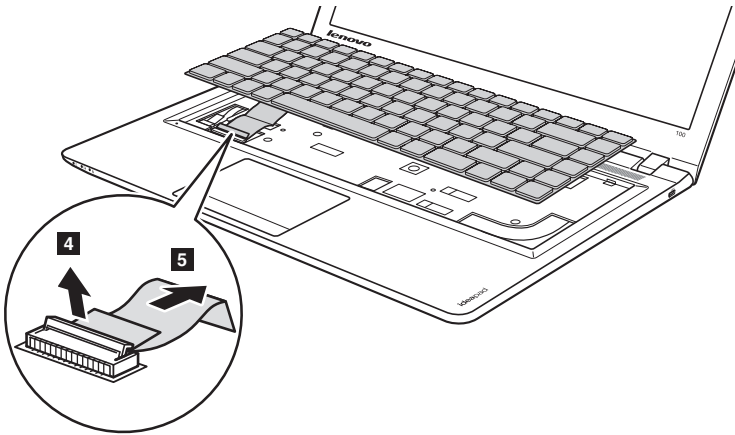

**Lenovo ideapad 100-15IBY**

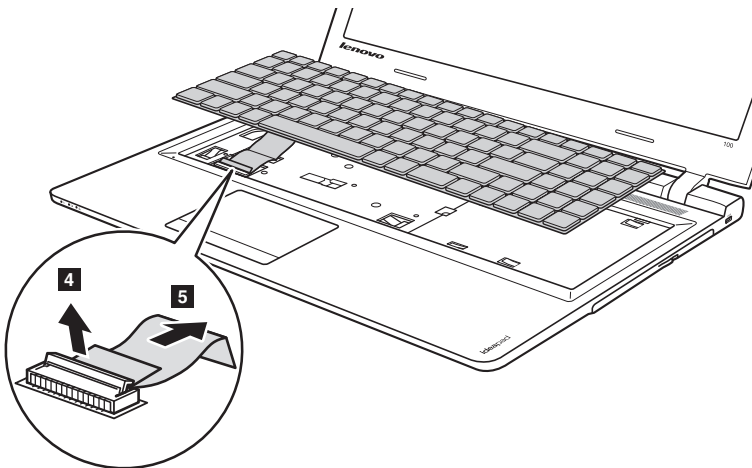

## ■ ■ Removing the optical drive (Lenovo ideapad 100-15IBY)

To remove the optical drive, do the following:

- 1 Remove the keyboard. For details, see “Removing the keyboard” on page 29.
- 2 Remove the screw shown in the illustration **1**.
- 3 Gently pull the optical drive out **2**.

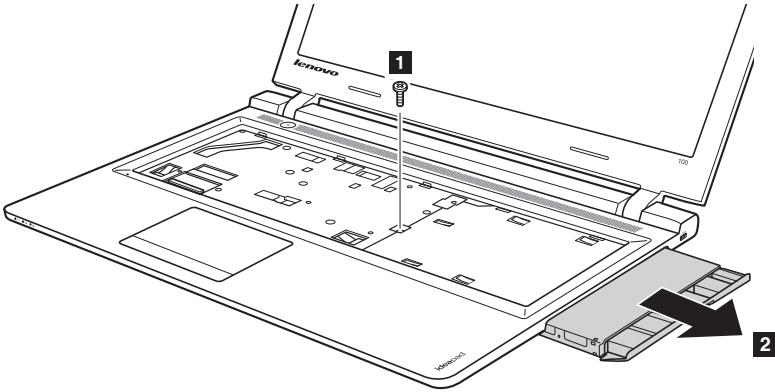

- 4 Remove the screw **3**, then remove the optical drive bracket in the direction shown by arrow **4**.

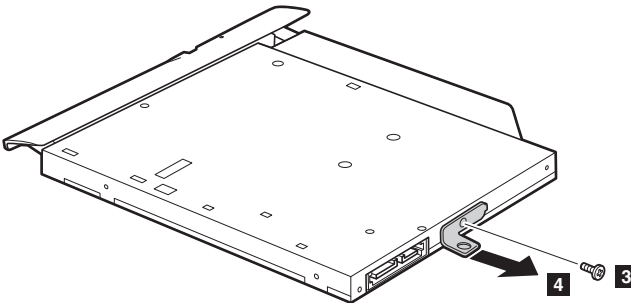

- 5 Carefully remove the optical drive bezel in the direction shown by arrow 5.

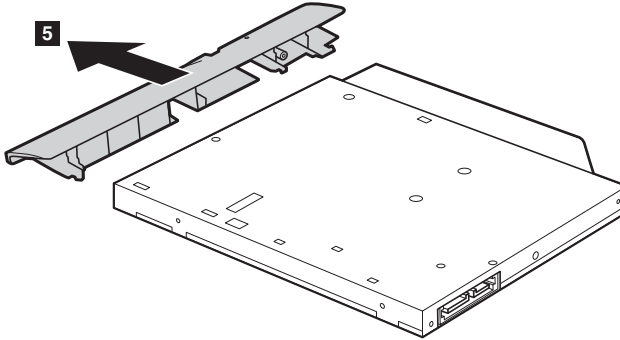

The following table provides a list of CRUs (Customer Replaceable Units) for your computer and informs you of where to find replacement instructions.

	Safety, Warranty, and Setup Guide	User Guide
AC power adapter	○	
Keyboard		○
Optical drive (Lenovo ideapad 100-15IBY)		○

## Trademarks

The following terms are trademarks or registered trademarks of Lenovo in the United States, other countries, or both.

Lenovo  
OneKey  
ideapad

Microsoft and Windows are trademarks of Microsoft Corporation in the United States, other countries, or both.

Other company, products, or service names may be trademarks or service marks of others.

***lenovo***

©Lenovo China 2015

en-US  
Rev. AA00