

ARCTIS 5

PRODUCT INFORMATION GUIDE

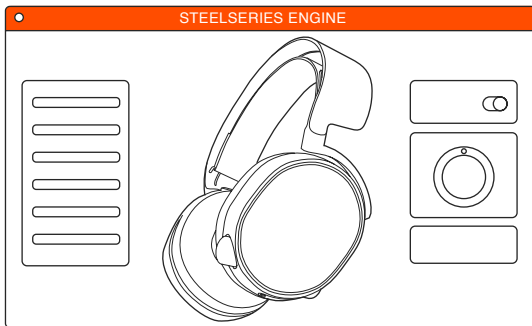

STEELSERIES ENGINE



To enjoy **DTS Headphone:X v2.0**, GameSense Integration, and custom lighting effects on your new Arctis 5 headset, download SteelSeries Engine at steelseries.com/engine

WELCOME TO ARCTIS.

Your new headset is the result of more than 15 years of gaming expertise and our unyielding pursuit of perfection. We poured our hearts into making your new Arctis, giving it the best gaming mic available, 7.1 surround sound and comfort and style unlike anything you've experienced before.



a.

PACKAGE CONTENTS

Product Information Guide

Headset

Main Cable (1.2m)

USB ChatMix Dial

4-pole 3.5mm Adapter

ENGINE REQUIREMENTS

Platforms:

Windows 7 +
Mac OS X 10.8 +

120 MB of free hard drive space
for installation

SYSTEM COMPATIBILITY

PC / MAC

DTS Headphone:X v2.0 Surround available
on Windows only. Software installation
required.

CONTENTS

SteelSeries Engine	1
Welcome	2
a. Info and Table of contents	3-4
b. Product overview	5-6
Setup	7
c. Microphone	8
d. Headband Installation	9
e. System Setting: Windows	10
f. System Setting: Mac	11
Translations	
Español	12
简体中文	14
繁體中文	16
日本語	18
한국어	20
Deutsch	22
Русский	24
Français	26
Italiano	28
Português	30
Regulatory	

b. PRODUCT OVERVIEW

*selected accessories available at steelseries.com

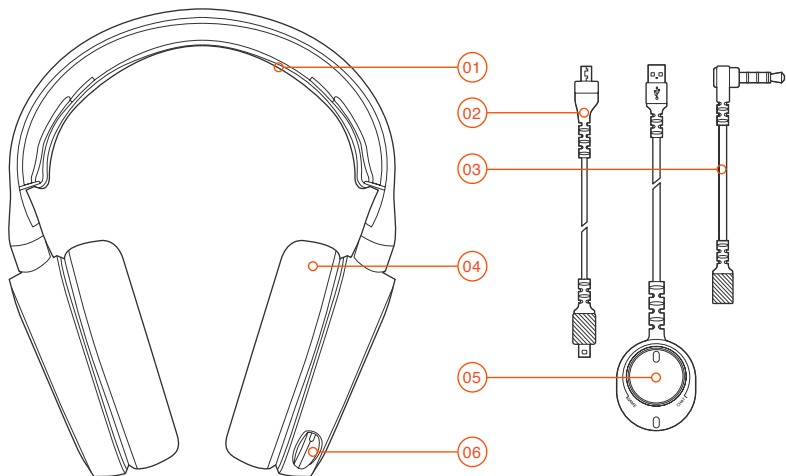

- 01 Ski Goggle Headband *
- 02 Main Headset Cable *
- 03 4-Pole 3.5 mm Adapter *
- 04 Airweave Ear Cushion *
- 05 USB Chatmix Dial
- 06 Retractable Microphone
- 07 Microphone Mute Button
- 08 Volume Control
- 09 Main Cable Jack
- 10 Headphone Share Jack

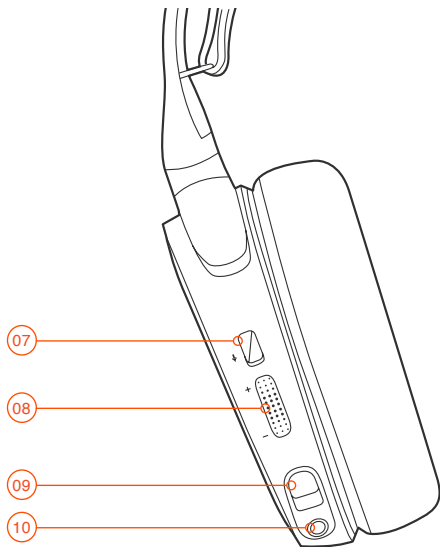

SETUP

find help at support.steelseries.com

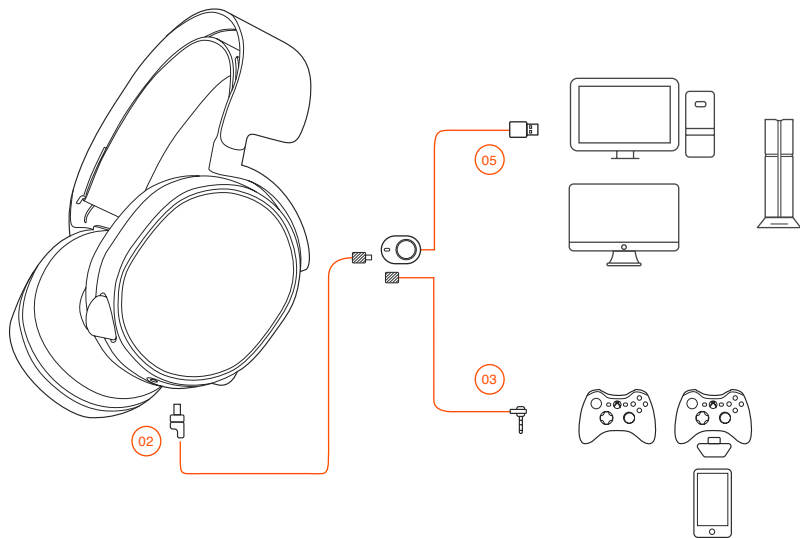

C. MICROPHONE

Retractable microphone

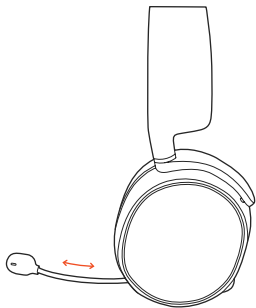

Positioning



c-1



top view



front view

Position the microphone close to the corner of your mouth with the flat surface facing you

d. **SKI GOGGLE HEADBAND**

accessory headbands available at steelseries.com

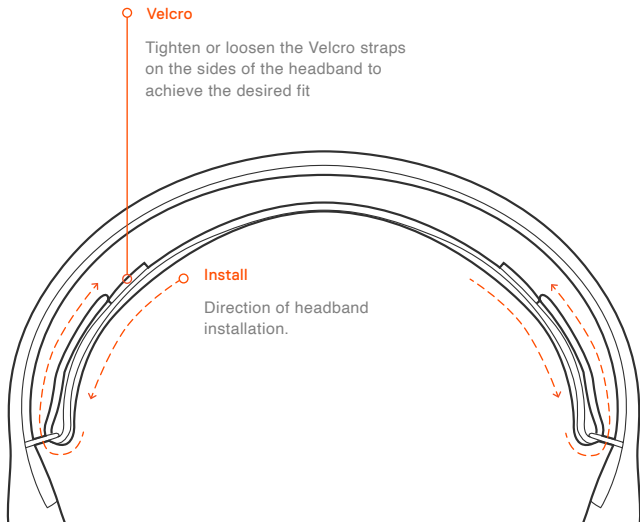

e. SYSTEM SETTING: WINDOWS

e-1

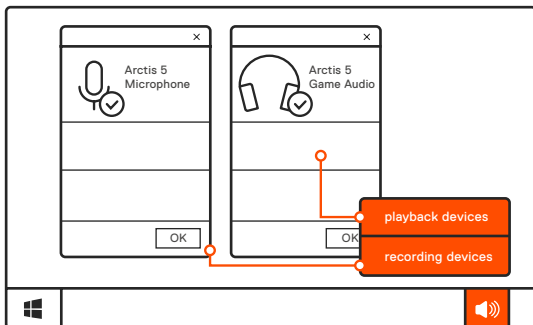

- e-2
- 01 Go to Sound Settings
 - 02 Under 'Playback' highlight Arctis 5 Game Audio and select 'Set Default'
 - 03 Under 'Recording' highlight Arctis 5 Chat and select 'Set Default'
 - 04 In your VoIP (chat) application select Arctis 5 Chat Audio as the default audio device

f. SYSTEM SETTING: MAC

find help at support.steelseries.com

f-1

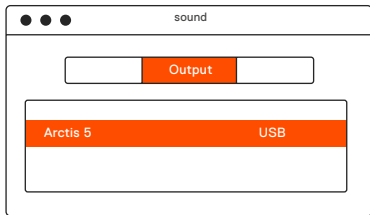

f-2

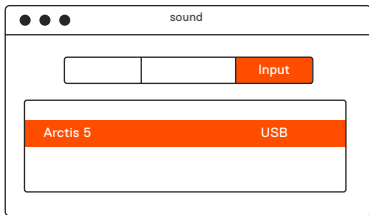

- f-3
- 01 Go to System Preferences > Sound
 - 02 Under 'Output' select Arctis 5 Game Audio
 - 03 Under 'Input' select Arctis 5 Chat
 - 04 In your VoIP (chat) application
select Arctis 5 Chat Audio as the
default audio device

ESPAÑOL

a. Contenido Del Paquete

Guía de Información del Producto

Auriculares

Cable principal (1.2m)

USB Cuadrante Chatmix

Adaptador de 3.5 mm 4 polos

Requisito de Engine

Plataformas:

Windows 7 +
Mac OS X 10.8 +

Se requieren 120 MB de espacio libre en el disco duro para la instalación

Compatibilidad del sistema

PC / MAC

Sonido envolvente DTS Headphone: X v2.0 disponible solo en Windows. Se requiere instalación de software

Descarga de Engine en
steelseries.com/engine

b. Descripción general del producto

- 01 Cinta para el cabello con gafas de esquí*
- 02 Cable principal de los auriculares*
- 03 Adaptador de 3,5 mm 4 polos*
- 04 Almohadilla para oídos Airweave*
- 05 Chatmix Cuadrante USB
- 06 Micrófono retráctil
- 07 Botón de silenciar el micrófono
- 08 Control del volumen
- 09 Conector del cable principal
- 10 Conector para compartir auriculares

* Los accesorios seleccionados están disponibles en steelseries.com

c. Micrófono

Micrófono retráctil

Posicionamiento

Coloque el micrófono cerca de la esquina de su boca con la superficie plana hacia su rostro

- c-1 Vista superior
Vista frontal

d. Cinta para el cabello con gafas de esquí

Velcro

Ajuste o afloje las tiras de velcro de los laterales de la cinta para lograr el ajuste deseado.

Instalación

Instrucción para instalar la cinta para cabello

Más cintas para cabello disponibles env steelseries.com

e. Ajustes de sistema: Windows

e-1 Dispositivos de reproducción
Audio para juegos Arctis 5

Dispositivos de grabación
Micrófono Arctis 5

e-2 01 Ir a ajustes de sonido

02 En "Reproducción", marca Audio para juegos Arctis 5 y selecciona "Establecer como predeterminado"

03 En "Grabación", marca Chat Arctis 5 y selecciona "Establecer como predeterminado"

04 En tu aplicación de VoIP (chat), selecciona Audio de chat Arctis 5 como dispositivo de audio predeterminado

f. Ajustes de sistema: Mac

f-1 Sonido

Salida: Arctis 5 Game Audio

f-2 Sonido

Entrada: Arctis 5 Game Audio

f-3 01 Ve a Preferencias del sistema > Sonido

02 En "Salida", selecciona Audio para juegos Arctis 5

03 En "Entrada", selecciona Chat Arctis 5

04 En tu aplicación de VoIP (chat), selecciona Audio de chat Arctis 5 como dispositivo de audio predeterminado

Solicite ayuda en support.steelseries.com

简体中文

a. 包装内含

产品信息指南

耳机

主线 (1.2m)

USB ChatMix Dial

4节3.5mm 转换头

Engine系统需求

适用平台

Windows 7 +

Mac OS X 10.8 +

安装需要120MB磁盘空间

系统兼容性

PC / MAC

只有Windows系统可设 DTS Head-
phone:X v2.0环绕音效。使用前需
先安装软件以及注册账号。

访问 steelseries.com/engine 下载

b. 产品概览

- 01 滑雪镜头带*
- 02 主耳机线*
- 03 四节3.5mm转换头*
- 04 Airweave 耳罩*
- 05 USB ChatMix 旋钮
- 06 伸缩式麦克风
- 07 麦克风静音按钮
- 08 音量控制
- 09 主线接口
- 10 耳机分享接口

* 勾选商品可在 steelseries.com 购买

c. 麦克风

伸缩式麦克风

麦克风位置

将麦克风放置于靠近您嘴角处，
宽平面朝向您自己。

c-1 鸟瞰图 正面图

d. 滑雪镜头带

尼龙搭扣

调整头带两侧的尼龙搭扣至适宜松紧度

安装

头带安装方法

更多头带样式请参考官网
steelseries.com

e. 系统设定: Windows

e-1 播放设备

Arctis 5 游戏耳机

录音设备

Arctis 5 麦克风

e-2 01 打开声音设定

02 在播放设备的视窗里选取
Arctis 5 游戏耳机并右键选择
设置为默认设备

03 在記錄設備窗口中選擇Arctis
5聊天, 然後右鍵單擊以選擇
設為默認設備

04 在您的VoIP (chat)应用程序
里将Arctis 5 游戏耳机设为默
认设备

f. 系统设定: Mac

f-1 声音

输出: Arctis 5 游戏耳机

f-2 输入: Arctis 5 游戏耳机

f-3 01 打开偏好设定 > 声音

02 在播放设备的视窗里选取
Arctis 5 游戏耳机并右键选择
设置为默认设备

03 在录音设备的视窗里选取
Arctis 5 麦克风并右键选择
设置为默认设备

04 在您的VoIP (chat)应用程序
里将Arctis 5 游戏耳机设为
默认设备

访问 support.steelseries.com 寻求帮助

繁體中文

a. 包裝內容

產品信息指南

耳機

主耳機線 (1.2m)

雙頭 3.5mm 延長線 (1.8m)

4節 3.5mm 轉接頭

Engine 系統需求

適用平台

Windows 7 +
Mac OS X 10.8 +

安裝需要 120MB 硬體空間

系統相容性

PC / MAC

只有Windows系統可設定DTS Head-
phone: X v2.0環繞音效。使用前須
先安裝軟體以及註冊帳號

訪問 steelseries.com/engine 下載

b. 產品概覽

- 01 滑雪鏡頭帶*
- 02 主耳機線*
- 03 四節 3.5mm 轉換頭*
- 04 Airweave 耳罩*
- 05 USB ChatMix 旋鈕
- 06 伸縮式麥克風
- 07 麥克風靜音按鈕
- 08 音量控制
- 09 主線接口
- 10 耳機分享接口

* 勾選商品可在 steelseries.com 購買

c. 麥克風

伸縮式麥克風

麥克風位置

將麥克風放置於靠近您嘴角處，
寬平面朝向您自己。

c-1 鳥瞰圖 正面圖

d. 滑雪鏡頭帶

魔鬼氈

調整頭帶兩側的魔鬼氈至適宜鬆緊度

安裝

頭帶安裝方法

更多頭帶樣式請參考官網
steelseries.com

e. 系統設定: Windows

e-1 播放設備

Arctis 5 遊戲耳機

錄音設備

Arctis 5 麥克風

e-2 01 打開聲音設定

- 02 在播放設備的視窗裡選取 Arctis 5 遊戲耳機並右鍵選擇設定為預設設備
- 03 在記錄設備窗口中選擇 Arctis 5 聊天，然後右鍵單擊以選擇設定為默認設備

- 04 在您的VoIP (chat)應用程式裡將 Arctis 5 遊戲耳機設定為預設設備

f. 系統設定: Mac

f-1 聲音

輸出: Arctis 5 遊戲耳機

f-2 聲音

輸入: Arctis 5 遊戲耳機

f-3 01 打開偏好設定 > 聲音

- 02 在播放設備的視窗裡選取 Arctis 5 遊戲耳機點右鍵選擇設定為預設設備
- 03 在錄音設備的視窗裡選取 Arctis 5 麥克風點右鍵選擇設定為預設設備
- 04 在您的VoIP (chat)應用程式裡將 Arctis 5 遊戲耳機設定為預設設備

訪問 support.steelseries.com 尋求幫助

日本語

a. パッケージの内容

製品情報ガイド

ヘッドセット

メインケーブル (1.2m)

USB ChatMix ダイアル

4極3.5mmプラグ

エンジン要件

プラットフォーム

Windows 7 +
Mac OS X 10.8 +

インストールに120MB以上の空き容量が必要。

システム互換性

PC / MAC

DTS Headphone:X v2.0 SurroundはWindowsでのみご利用いただけます。ソフトウェアのインストールとアカウントの登録が必要です。

ダウンロードは steelseries.com/engine から

b. 製品概要

- 01 スキーゴーグルヘッドバンド*
- 02 メインヘッドセットケーブル*
- 03 4極3.5mmプラグ*
- 04 Airweave イヤークッション*
- 05 USB ChatMix ダイアル
- 06 リトラクタブルマイク
- 07 マイク消音ボタン
- 08 音量コントロール
- 09 メインケーブルジャック
- 10 ヘッドフォン共有ジャック

steelseries.com で厳選されたアクセサリーをお求めいただけます

c. マイク

リトラクタブルマイク

ポジショニング

マイクの位置は、平らな面が口の端に来るように調節してください。

c-1 トップビュー フロントビュー

d. スキーゴーグルヘッドバンド

面ファスナー

きつすぎず緩すぎない、丁度いい装着感になるように、ヘッドバンド両側のストラップの面ファスナーを調整してください。

インストール

ヘッドバンドの取り付け方法の説明です。

他のヘッドバンドをお求めの場合は steelseries.com をご覧ください

e. システム設定: Windows

e-1 再生機器

Arctis 5 ゲームオーディオ

記録機器

Arctis 5 マイク

e-2 01 サウンド設定に進む

02 [再生] から [Arctis 5 ゲームオーディオ] をハイライトし、[デフォルトに設定] を選択

03 [録音] から [Arctis 5 チャット] をハイライトし、[デフォルトに設定] を選択

04 ご利用の VoIP (チャット) アプリケーションで [Arctis 5 チャットオーディオ] をデフォルトのオーディオ機器として選択します

f. システム設定: Mac

f-1 サウンド

出力: Arctis 5 ゲームオーディオ

f-2 サウンド

入力: Arctis 5 ゲームオーディオ

f-3 01 [システム設定] > [サウンド] と進みます

02 [出力] から [Arctis 5 ゲームオーディオ] を選択

03 [入力] から [Arctis 5 マイク] を選択

- 04 ご利用のVoIP (チャット) アプリケーションで [Arctis 5 チャットオーディオ] をデフォルトのオーディオ機器として選択します

ヘルプについては
support.steelseries.com
をご覧ください

한국인

a. 패키지 구성

제품 정보 가이드

헤드셋

메인 케이블 (1.2m)

듀얼 3.5mm 연장 케이블 (1.8m)

4극 3.5mm 어댑터

Engine 요구 사양

플랫폼

Windows 7 +
Mac OS X 10.8 +

설치에 120 MB 의 하드 드라이브
공간 필요.

시스템 호환

PC / MAC

DTS Headphone: X v2.0 Surround 는
Windows에서만 지원. 소프트웨어 설치
및 계정 등록이 필요합니다

steelseries.com/engine
에서 다운로드할 수 있습니다

b. 제품 개요

- 01 스키고글 헤드밴드*
- 02 메인 헤드셋 케이블*
- 03 4극 3.5 mm 어댑터*
- 04 Airweave 이어패드*
- 05 USB ChatMix Dial
- 06 접이식 마이크
- 07 마이크 음소거 버튼
- 08 볼륨 조절
- 09 메인 케이블 잭
- 10 헤드폰 공유 잭

c. 마이크

접이식 마이크

위치 조절

평평한 쪽이 얼굴을 향하도록 하여 마이크를 입가 근처에 고정시키십시오

- c-1 평면 시점
- 정면 시점

d. 스키고글 헤드밴드

벨크로

헤드셋 측면의 벨크로 띠의 부착을 조절하여 적절히 착용하십시오

설치

헤드밴드 설치 방향

steelseries.com 의 다른 헤드밴드 보기

e. 시스템 설정: Windows

e-1 재생 장치

Arctis 5 게임 오디오

녹음 장치

Arctis 5 마이크

e-2 01 소리 설정으로 이동하십시오

02 '재생' 탭에서 Arctis 5 게임 오디오를 선택하고 '기본 장치로 설정' 을 체크하십시오

03 '녹음' 탭에서 Arctis 5 잡담 선택하고 기본 장치로 설정' 을 체크하십시오

04 사용하는 VoIP(채팅) 응용프로그램에서 Arctis 5 Chat Audio 를 기본 오디오 장치로 선택하십시오

f. 시스템 설정: Mac

f-1 소리

출력 : Arctis 5 게임 오디오

f-2 소리

입력 : Arctis 5 게임 오디오

f-3 01 시스템 환경설정 > 사운드로 이동하십시오

02 '출력' 탭에서 Arctis 5 게임 오디오를 선택하십시오

03 '입력' 탭에서 Arctis 5 마이크를 선택하십시오

- 04 사용하는 VoIP(채팅) 응용프로그램에서 Arctis 5 Chat Audio를 기본 오디오 장치로 선택하십시오

도움말은 support.steelseries.com에서 보실 수 있습니다

DEUTSCH

a. Packungsinhalt

Produktinformationen

Headset

Hauptkabel (1.2 m)

USB ChatMix Dial

4-poliger 3.5 mm Adapter

Engine-Anforderungen

Plattformen :

Windows 7 +

Mac OS X 10.8 +

120 MB freien Platz auf der Festplatte für die Installation

Compatibilité du système

PC / MAC

DTS Headphone:X v2.0 Surround ist nur für Windows verfügbar. Softwareinstallation erforderlich

Download bei steelseries.com/engine

b. Produktüberblick

- 01 „Skibrillen“-Stirnband*
- 02 Haupt-Headset-Kabel*
- 03 4-poliger 3.5 mm Adapter*
- 04 Airweave Ohrpolster*
- 05 USB ChatMix Dial
- 06 Einklappbares Mikrofon
- 07 Stummschalttaste des Mikrofon
- 08 Lautstärkeregler
- 09 Hauptkabelbuchse
- 10 Gemeinsame Kopfhörerbuchse

* Ausgewähltes Zubehör bei steelseries.com

c. Mikrofon

Einklappbares Mikrofon

Platzierung

Platziere das Mikrofon in die Nähe deines Mundwinkels, wobei die flache Oberfläche in deine Richtung deuten soll.

- c-1 Ansicht von oben
Seitenansicht

d. „Skibrillen“-Stirnband

Klettverschluss

Das Stirnband lässt sich anhand des Klettverschlusses auf die gewünschte Passform einstellen.

Installieren

Richtung der Stirnband-Installation

Weitere Stirnbänder bei steelseries.com

e. Systemeinstellungen: Windows

e-1 Wiedergabegeräte

Arctis 5 Game Audio

Aufnahmegерäte

Arctis 5 Mikrofon

e-2 01 Zu Sound-Einstellungen

02 Wähle bei 'Playback' Arctis 5 Game Audio und dann 'Standard'

03 Wähle bei 'Aufnahme' Arctis 5 Chat und dann 'Standard'

04 Wähle in deiner VoIP (Chat) Anwendung Arctis 5 Chat Audio als das Standard-Tongerät

f. Systemeinstellungen: Mac

f-1 Sound

Ausgabe: Arctis 5 Game Audio

f-2 Sound

Eingabe: Arctis 5 Game Audio

f-3 01 Gehe zu Systemeinstellungen > Sound

- 02 Wählen unter 'Ausgabe'
Arctis 5 Game Audio
- 03 Wählen unter 'Eingabe'
Arctis 5 Chat
- 04 Wählen in deiner VoIP
(Chat) Anwendung Arctis
5 Chat Audio als das Stan-
dard-Tongerät

Solicite ayuda en
support.steelseries.com

РУССКИЙ

- a. **Содержимое упаковки**
 - Сведения об изделии
 - Наушники
 - Основной кабель (1.2 m)
 - USB-колёсиком ChatMix
 - Переходник 3,5мм

Требования движка

Платформы:

Windows 7 +
Mac OS X 10.8 +

Для установки нужно 120 МБ
свободного места на жёстком
диске.

Системная совместимость

ПК / MAC

Система DTS Headphone:X v2.0
Surround. (только для Windows)
Требуется установка
программного обеспечения
и регистрация аккаунта

Загрузить steelseries.com/engine

- b. **Обзор изделия**

- 01 Оголовье как у лыжных очков*
- 02 Основной кабель наушников*
- 03 Переходник 3.5мм*
- 04 Амбушюры Airweave*
- 05 USB-колёсиком ChatMix
- 06 Выдвижной микрофон

- 01 Кнопка отключения микрофона
- 02 Настройка громкости
- 03 Переходник основного кабеля
- 04 Переходник для второго пользователя

* Аксессуары steelseries.com

c. микрофон

Выдвижной микрофон

Platzierung

Расположите микрофон около уголка рта, плоской стороной к себе.

- c-1 Вид сверху
- Вид спереди

d. Оголовье как у лыжных очков

Велкро

Затяните или ослабьте полосы Велкро по бокам оголовья, чтобы оно лучше сидело

Другие модели steelseries.com

e. Системные настройки: Windows

e-1 Воспроизведение звука

Игровой звук Arctis 5

Запись звука

Микрофон Arctis 5

e-2 01 Перейдите к настройкам звука.

02 В разделе «Воспроизведение» выберите «Игровой звук Arctis 5», а затем — «По умолчанию».

03 В разделе «Запись» выберите «чат Arctis 5», а затем — «По умолчанию».

04 В приложении VoIP (чате) установите «звук чата Arctis 5» по умолчанию.

f. Системные настройки: Mac

f-1 Звук

вход: Игровой звук Arctis 5

f-2 Звук

выход: Игровой звук Arctis 5

- f-3 01** Перейдите в раздел «Системные настройки > Звук».
- 02** В разделе «Вход» выберите «Игровой звук Arctis 5».
- 03** В разделе «Выход» выберите «чат Arctis 5».
- 04** В приложении VoIP (чате) установите «звук чата Arctis 5» по умолчанию.

Техподдержка
support.steelseries.com

FRANÇAIS

- a. Contenu de l'emballage**
- Guide d'informations produit
 - Casque audio
 - Câble principal (1,2 m)
 - Cadran De Réglage USB ChatMix
 - Adaptateur 4 pôles 3,5 mm

Prérequis Engine

Plateformes :

Windows 7 +
Mac OS X 10.8 +

120 Mo d'espace disque dur disponible pour l'installation

Compatibilité du système

PC / MAC

Casque DTS X v2.0 Surround disponible pour Windows uniquement. L'installation du logiciel

Téléchargements ici steelseries.com/engine

b. Présentation du produit

- 01 Serre-tête de masque de ski*
- 02 Câble principal du casque audio*
- 03 Adaptateur 4 pôles 3,5 mm*
- 04 Coussinet d'oreille Airweave*
- 05 Cadran De Réglage USB ChatMix
- 06 Microphone rétractable
- 07 Bouton Muet du microphone

- 08 Contrôle du volume
- 09 Prise câble principal
- 10 Prise partage casque audio

* Sélection d'accessoires disponibles ici steelseries.com

c. Microphone

Microphone rétractable

Positionnement

Placez le microphone près du coin de votre bouche, la surface plate vous faisant face

- c-1 Vue du haut
Vue avant

d. Serre-tête de masque de ski

Velcro

Serrez ou desserrez les lanières en Velcro sur les côtés du serre-tête pour un confort optimal.

Instalación

Instruction de l'installation du serre-tête.

Plus de serre-têtes ici steelseries.com

e. Configuration système: Windows

e-1 Périphériques de lecture

Audio de jeu Arctis 5

Périphériques d'enregistrement

Microphone Arctis 5

e-2 01 Ouvrir la configuration sonore .

02 Sous « Lecture », activez « Audio de jeu Arctis 5 » et sélectionnez « Par défaut ».

03 Sous « Enregistrement », activez « Chat Arctis 5 » et sélectionnez « Par défaut » .

04 Dans votre application VoIP (de chat), sélectionnez « Audio chat Arctis 5 » en tant que périphérique audio par défaut.

f. Configuration système: Mac

f-1 Son

Sortie: Audio de jeu Arctis 5

f-2 Son

Entrée: Microphone Arctis 5

- f-3 01** Ouvrez « Préférences système > Son »
- 02** Sous « Sortie », sélectionnez « Audio de jeu Arctis 5 »
- 03** Sous « Entrée », sélectionnez « Chat Arctis 5 »
- 04** Dans votre application VoIP (de chat), sélectionnez « Audio chat Arctis 5 » en tant que périphérique audio par défaut.

Vous obtiendrez de l'aide ici support.steelseries.com

ITALIANO

- a. Contenuti della confezione**
- Guida informazioni sul prodotto
- Cuffie
- Cavo principale (1.2m)
- USB Barra Chatmix
- Cavo jack 3.5 mm 4 poli

Requisiti Engine

Piattaforma:

Windows 7 +
Mac OS X 10.8 +

120 MB di spazio libero sull'hard drive per l'installazione

Compatibilità di sistema

PC / MAC

DTS Headphone:X v2.0 Surround disponibile solo per Windows.
Installazione software

scarica da steelseries.com/engine

b. Generalità sul prodotto

- 01 Archetto stile occhiali da sci*
- 02 Cavo cuffia principale*
- 03 Cavo jack 3.5 mm 4 poli*
- 04 Cuscinetti Airweave*
- 05 USB Barra Chatmix
- 06 Microfono retrattile

- 07 Pulsante microfono muto
- 08 Controllo del volume
- 09 Jack cavo principale
- 10 Splitter per cuffie

* accessori selezionati disponibili su steelseries.com

c. **Microfono**

Microfono retrattile

Posizionamento

Sistema il microfono vicino all'angolo della bocca con la superficie piatta rivolta verso di te

- c-1 Vista dall'alto
- Vista frontale

d. **Archetto stile occhiali da sci**

Velcro

Stringi o allenta le cinghie di velcro ai lati dell'archetto per ottenere la misura desiderata

Montaggio

Senso di montaggio dell'archetto.

Trova altri archetti su steelseries.com

e. **Impostazioni di sistema: Windows**

e-1 Periferica di riproduzione

Audio del gioco Arctis 5

Periferica di registrazione

Microfono Arctis 5

e-2 01 Vai a Impostazioni audio.

02 In "Riproduzione" evidenzia audio del gioco Arctis 5 quindi seleziona "Impostazioni predefinite"

03 In "Registrazione" evidenzia il chat Arctis 5 quindi seleziona "Impostazioni predefinite"

04 Seleziona Arctis 5 Chat Audio come periferica audio predefinita per la tua applicazione VoIP (chat).

f. **Impostazioni di sistema: Mac**

f-1 Audio

Uscita: Audio del gioco Arctis 5

f-2 Audio

Entrée: Microfono Arctis 5

- f-3 01** apri preferenze di sistema
> Audio
- 02** In "Uscita" seleziona Audio del gioco Arctis 5
- 03** In "Ingresso" seleziona Chat Arctis 5
- 04** Seleziona Arctis 5 Chat Audio come periferica audio predefinita per la tua applicazione VoIP (chat)
- Per assistenza vai su support.steelseries.com

PORTUGUÊS

- a. Conteúdo do pacote**
- Guia de informação de produto
- Headset
- Cabo principal (1.2m)
- USB ChatMix Dial
- Adaptador 3.5mm de 4 hastes

Requisitos do Engine

Plataformas:

Windows 7 +
Mac OS X 10.8 +

120 MB de espaço livre em disco para a instalação

Compatibilidade do sistema

ПК / MAC

Fone de ouvido DTS:X v2.0
Surround disponível apenas no Windows
Necessário registro de conta

faça download em steelseries.com/engine

b. Visão geral do produto

- 01 Faixa de óculos de esqui *
- 02 Cabo principal do headset *
- 03 Adaptador 3,5mm de 4 hastes *
- 04 Almofada de orelha Airweave *
- 05 USB ChatMix Dial
- 06 Microfone retrátil
- 07 Botão de silenciar microfone

- 08 Controle de volume
- 09 Entrada do cabo principal
- 10 Entrada de compartilhar fone

* acessórios selecionados disponíveis em steelseries.com

c. Microfone

Microfone retrátil

Posicionamento

Posicione o microfone perto do canto da sua boca com a superfície lisa virada para você

- c-1 Visão de cima
Visão frontal

d. Faixa de óculos de esqui

Velcro

Aperte ou afrouxe as tiras de velcro nos lados da faixa para chegar no ponto desejado

Instalação

Direção da instalação da faixa.

mais faixas em steelseries.com

e. Configurações de sistema: Windows

- e-1 Dispositivos de reprodução
Áudio de jogo Arctis 5

Dispositivos de gravação
Microfone Arctis 5

- e-2 01 Ir para configurações de som.
 - 02 Sob "Reprodução" selecione áudio de jogo Arctis 5 e escolha "Definir padrão"
 - 03 Sob "Gravação" selecione chat Arctis 5 e escolha "Definir padrão"
 - 04 No seu aplicativo de VoIP (chat) selecione áudio de chat Arctis 5 como o dispositivo de áudio padrão..

f. Impostazioni di sistema: Mac

- f-1 Som
Saída: Áudio de jogo Arctis 5

- f-2 Som
Entrada: Microfone Arctis 5

- f-3 01** vá para Preferências do sistema > Som
- 02** Sob "Saída", selecione áudio de jogo Arctis 5
- 03** Sob "Entrada", selecione chat Arctis 5
- 04** No seu aplicativo de VoIP (chat) selecione áudio de chat Arctis 5 como o dispositivo de áudio padrão.

encontre ajuda em
support.steelseries.com



Europe – EU Declaration of Conformity

Hereby, SteelSeries ApS. declares that the equipment which is compliance with directive RoHS 2.0 (2015/863/EU), R.E.D (2014/53/EU), EMC Directive (2014/30/EU), and LVD (2014/35/EU) which are issued by the Commission of the European Community.

The full text of the EU declaration of conformity is available at the following internet address: <https://steelseries.com/>

SteelSeries ApS. hereby confirms, to date, based on the feedback from our suppliers indicates that our products shipping to the EU territory comply with REACH (Registration, Evaluation, Authorization, and Restriction of Chemicals - (EC) 1907/2006) compliance program. We are fully committed to offering REACH compliance on the products and posting accurate REACH compliance status for the all of products.



WEEE

This product must not be disposed of with your other household waste or treat them in compliance with the local regulations or contact your local city office, your household waste disposal service or the shop where you purchased the product.

Türkiye Cumhuriyeti: EEE Yönetmeliğine Uygundur

Ukraine RoHS:

Обладнання відповідає вимогам Технічного регламенту щодо обмеження використання деяких небезпечних речовин в електричному та електронному обладнанні, затвердженого постановою Кабінету Міністрів України від 3 грудня 2008 № 1057

This product is compliant with requirements of Vietnam Circular No. 30/2011/TT-BCT Regulations "STIPULATING TEMPORARILY THE PERMISSIBLE CONTENT LIMITATION OF SOME TOXIC CHEMICALS IN THE ELECTRONIC, ELECTRICAL PRODUCTS"

Restriction on Hazardous Substances statement (India)

This product complies with the "India E-waste Rule 2011" and prohibits use of lead, mercury, hexavalent chromium, polybrominated biphenyls or polybrominated diphenyl ethers in concentrations exceeding 0.1 weight % and 0.01 weight % for cadmium, except for the exemptions set in Schedule 2 of the Rule.

《废弃电器电子产品回收处理管理条例》提示性说明

为了更好地关爱及保护地球，当用户不再需要此产品或产品寿命终止时，请遵守国家废弃电器电子产品回收处理相关法律法规，将其交给当地具有国家认可的回收处理资质的厂商进行回收处理。



Federal Communication Commission Interference Statement

This device complies with Part 15 of the FCC Rules. Operation is subject to the following two conditions: (1)

This device may not cause harmful interference, and (2) this device must accept any interference received, including interference that may cause undesired operation.

This equipment has been tested and found to comply with the limits for a Class B digital device, pursuant to Part 15 of the FCC Rules. These limits are designed to provide reasonable protection against harmful interference in a residential installation. This equipment generates, uses and can radiate radio frequency energy and, if not installed and used in accordance with the instructions, may cause harmful interference to radio communications. However, there is no guarantee that interference will not occur in a particular installation. If this equipment does cause harmful interference to radio or television reception, which can be determined by turning the equipment off and on, the user is encouraged to try to correct the interference by one of the following measures:

- Reorient or relocate the receiving antenna.
- Increase the separation between the equipment and receiver.
- Connect the equipment into an outlet on a circuit different from that to which the receiver is connected.
- Consult the dealer or an experienced radio/TV technician for help.

FCC Caution: Any changes or modifications not expressly approved by the party responsible for compliance could void the user's authority to operate this equipment.

This transmitter must not be co-located or operating in conjunction with any other antenna or transmitter.

Note: The country code selection is for non-US model only and is not available to all US model. Per FCC regulation, all WiFi product marketed in US must fixed to US operation channels only.

Regions	Contact Information	
USA	656 W Randolph St, Suite 3E Chicago, IL 60661, USA	+1 312 258 9467

More information and support from <https://steelseries.com/>

Industry Canada Statement:

This device complies with RSS standards of the Industry Canada Rules. Operation is subject to the following two conditions: (1) This device may not cause harmful interference, and (2) this device must accept any interference received, including interference that may cause undesired operation.

Ce dispositif est conforme à la norme CNR d'Industrie Canada applicable aux appareils radio exempts de licence. Son fonctionnement est sujet aux deux conditions suivantes: (1) le dispositif ne doit pas produire de brouillage préjudiciable, et (2) ce dispositif doit accepter tout brouillage reçu, y compris un brouillage susceptible de provoquer un fonctionnement indésirable.

Radiation Exposure Statement:

This equipment complies with FCC/IC radiation exposure limits set forth for an uncontrolled environment.

Déclaration d'exposition aux radiations:

Cet équipement est conforme aux limites d'exposition aux rayonnements FCC/IC établies pour un environnement non contrôlé.

This Class B digital apparatus complies with Canadian ICES-003.

Cet appareil numérique de la classe B est conforme à la norme NMB-003 du Canada.

이 기기는 가정용 (B급) 전자파적합기기로서 주로 가정에서 사용하는 것을 목적으로 하며, 모든 지역에서 사용할 수 있습니다



1. 상호명: SteelSeries ApS.
2. 기기명칭: Headset and Sound Card
3. 모델명: HS-00011/ SC-00006
4. 인증번호: R-REM-SS4-HS-00011
R-REM-SS4-SC-00006
5. 제조사/제조국: SteelSeries ApS./China



この装置は、情報処理装置等電波障害自主規制協議会(VCCI)の基準に基づくクラスB情報技術装置です。この装置、家庭環境で使用することを目的としていますが、この装置がラジオやテレビジョン受信機に近接して使用されると、受信障害を引き起こすことがあります。取扱説明書に従って正しい取り扱いをしてください。



该电子电气产品含有某些有害物质，在环保使用期限内可以放心使用，超过环保使用期限之后则应该进入回收循环系统。



Custom Union Compliance.
(Russia / Belarus / Kazakhstan)



ACMA Compliance (Australia/ New-Zealand)



Direct Current

Parts	Substance Name	EC Number	CAS Number	Contained (PPM)
LED	Hexahydromethylphthalic	247-094-1	25550-51-0	181125

· Please do not open the product and touch LED directly.

The RoHS test method is based on the standards JIS C 0950 and CNS 15663.

設備名稱: Equipment name	耳機/Headset		型號 (型式): Type designation		HS-00011	
單元 Unit	限用物質及其化學符號 Restricted substances and its chemical symbols					
	鉛 Lead (Pb)	汞Mercury (Hg)	鎘Cadmium (Cd)	六價鉻 Hexavalent chromium (Cr+6)	多溴聯苯 Polybrominated biphenyls (PBB)	多溴二苯醚 Polybrominated diphenyl ethers (PBDE)
塑膠部件/Plastic	○	○	○	○	○	○
電路板及元件/PCBA	—	○	○	○	○	○
線材/Cables	—	○	○	○	○	○
金屬部件/Metal	—	○	○	○	○	○
<p>備考1. “超出0.1 wt %”及“超出0.01 wt %”係指限用物質之百分比含量超出百分比含量基準值。 Note 1: “Exceeding 0.1 wt %” and “exceeding 0.01 wt %” indicate that the percentage content of the restricted substance exceeds the reference percentage value of presence condition.</p> <p>備考2. “○”係指該項限用物質之百分比含量未超出百分比含量基準值。 Note 2: “○” indicates that the percentage content of the restricted substance does not exceed the percentage of reference value of presence.</p> <p>備考3. “—”係指該項限用物質為排除項目。 Note 3: The “-” indicates that the restricted substance corresponds to the exemption</p>						

Product(產品名稱/产品名称): Headset (耳機/耳机)

Model No. (型號/型号): HS-00011

Rated (額定值/额定值): 5V 300mA

Operating Temperature: 0 to + 40 °C.

Made in China 中國製造/中国制造

根据中国大陆《电子电气产品有害物质限制使用标识要求》，以下部分列出了产品中可能包含的有害物质的名称和含量：

零部件名称	有害物质					
	铅 (Pb)	汞 (Hg)	镉 (Cd)	六价铬 (Cr(VI))	多溴联苯 (PBB)	多溴二苯醚 (PBDE)
塑料	○	○	○	○	○	○
电路板组件	×	○	○	○	○	○
其他线材	×	○	○	○	○	○

*：电路板组件包括印刷电路板及其构成的零部件，如电阻、电容、集成电路、连接器等。

本表格依据SJ/T 11364的规定编制。

○：表示该有害物质在该部件所有均质材料中的含量均在 GB/T 26572规定的限量要求以下。

×：表示该有害物质至少在该部件的某一均质材料中的含量超出GB/T 26572规定的限量要求；

上表中打“×”的部件，应功能需要，部分有害物质含量超出GB/T 26572规定的限量要求，但是符合欧盟RoHS法规要求(属于豁免部分)。

Region	Address	Telephone
Asia 亞洲	4F.-4, No. 186, Jian 1st Rd., Zhonghe Dist., New Taipei City 235603, Taiwan 新北市中和區建一路186號4樓及4樓之4	+886 2 8227 1999
Europe	Havneholmen 8, 1 st Floor, 2450 Copenhagen SV, Denmark	+45 702 500 75
USA	656 W Randolph St., Suite 3E, Chicago, IL 60661, USA	+1 312 258 9467

More information and support from <https://steelseries.com/>



learn more at steelseries.com