

SENCOR®

SWS 9700



USER MANUAL

NÁVOD K OBSLUZE

NÁVOD NA OBSLUHU

HASZNÁLATI ÚTMUTATÓ

INSTRUKCJA OBSŁUGI

**PROFESSIONAL WEATHER STATION
WITH WIRELESS 5-IN-1 SENSOR**

**PROFESIONÁLNÍ METEOSTANICE
S BEZDRÁTOVÝM SNÍMAČEM**

**PROFESIONÁLNA METEOSTANICA
S BEZDRŤOVÝM SNÍMAČOM**

**PROFI METEOROLÓGIAI ÁLLOMÁS
VEZETÉK NÉLKÜLI ADATÁTVITELLEL**

**PROFESJONALNA STACJA POGODOWA
Z CZUJNIKIEM BEZPRZEWODOWYM**

EN **CZ** **SK** **HU** **PL**

PRECAUTIONS

- Read and keep these instructions.
- Heed all warnings.
- Follow all instructions.
- Do not subject the unit to excessive force, shock, dust, temperature or humidity.
- Do not cover the ventilation holes with any items such as newspapers, curtains etc.
- Do not immerse the unit in water. If you spill liquid over it, dry it immediately with a soft, lint-free cloth.
- Do not clean the unit with abrasive or corrosive materials.
- Do not tamper with the unit's internal components. This invalidates the warranty.
- Only use fresh batteries. Do not mix new and old batteries.
- Only use attachments/accessories specified by the manufacturer.
- Images shown in this manual may differ from the actual display.
- When disposing of this product, ensure it is collected separately for special treatment.
- Placement of this product on certain types of wood may result in damage to its finishing for which manufacture will not be responsible. Consult the furniture manufacturer's care instructions for information.
- The socket-outlet shall be installed near the equipment and shall be easily accessible.
- Do not dispose old batteries as unsorted municipal waste. Collection of such waste separately for special treatment is necessary.
- The technical specifications for this product and the contents of the user manual are subject to change without notice.
- Place the console at least 1m from the adaptor.
- The main unit is only suitable for mounting at height < 2m.
- Risk of explosion if battery is replaced by an incorrect type. Dispose of used batteries according to the instructions.

INTRODUCTION

Thank you for your purchase of this delicate Professional Weather Station With Wireless 5-IN-1 Sensor.

The wireless 5-IN-1 sensor contains a self-emptying rain collector for measuring rainfall, anemometer, and wind vane, temperature and humidity sensors. It is fully assembled and calibrated for your easy installation. It sends data by a low power radio frequency to the Display Main Unit up to 150m away (line of sight).

The display Main Unit displays all the weather data received from the 5-IN-1 sensor outside. It remembers the data for a time range for you to monitor and analyze the weather status for past 24 hours. It has advance feature such as the HI/LO Alert alarm which will alert the user when the set high or low weather criteria are met. The barometric pressure records are computed to give users forthcoming weather forecast and stormy warning. Day and date stamps are also provided to the corresponding maximum and minimum records for each weather details.

The system also analyzes the records for your convenient viewing, such as the display of rainfall in terms of rain rate, daily, weekly and monthly records, whereas wind-speed in different levels. Different useful readings such as Wind-chill, Heat Index, Dew-point, Comfort level are also provided.

With Radio-controlled / Atomic clock feature built-in, the system is truly a remarkable personal Professional Weather Station for your own backyard.

Note:

This instruction manual contains useful information on the proper use and care of this product. Please read this manual through to fully understand and enjoy its features, and keep it handy for future use.

OVERVIEW

LCD DISPLAY

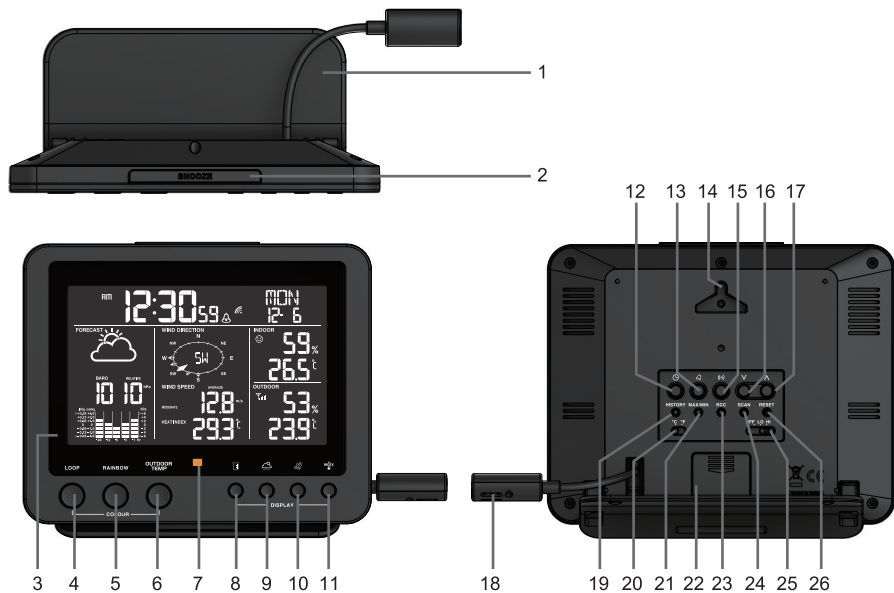

1. Table stand
2. **[SNOOZE / LIGHT]** button
3. LCD display
4. **[LOOP]** button
5. **[RAINBOW]** button
6. **[OUTDOOR TEMP]** button
7. Alert LED indicator
8. **[RAINFALL]** button
9. **[BARO]** button
10. **[WIND]** button
11. **[INDEX]** button
12. **[CLOCK]** button
13. **[ALARM]** button
14. Wall-mounting hole
15. **[ALERT]** button
16. **[V]** button
17. **[^]** button
18. DC jack / Temperature sensor
19. **[HISTORY]** button
20. **[°C/°F]** slide switch
21. **[MAX/MIN]** button
22. Battery door - Accommodates lithium battery CR2032 for back-up.
23. **[RCC]** button
24. **[SCAN]** button
25. **[OFF / LO / HI]** slide switch
26. **[RESET]** button

WIRELESS 5-IN-1 SENSOR

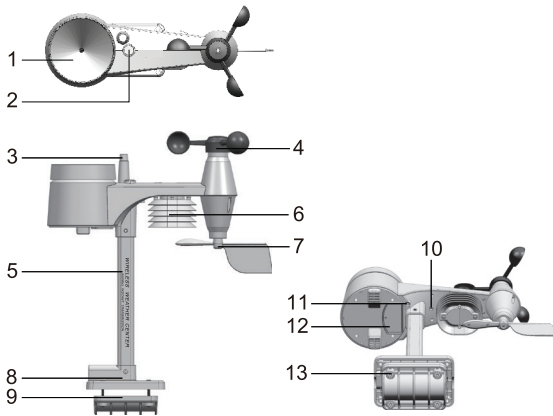

1. Rain collector
2. Balance indicator
3. Antenna
4. Wind cups
5. Mounting pole
6. Radiation shield
7. Wind vane
8. Mounting base
9. Mounting claim
10. Red LED indicator
11. [RESET] button
12. Battery door
13. Screws

RAIN GAUGE

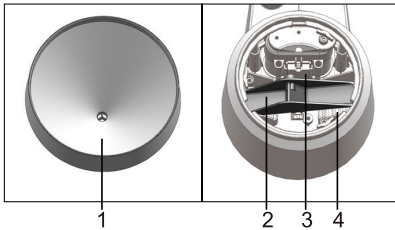

1. Rain collector
2. Tipping bucket
3. Rain sensor
4. Drain holes

TEMPERATURE AND HUMIDITY SENSOR

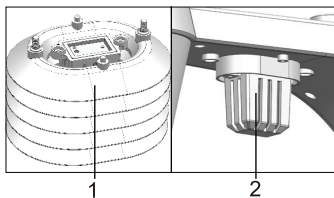

1. Radiation shield Sensor casing
2. Temperature and humidity sensor

WIND SENSOR

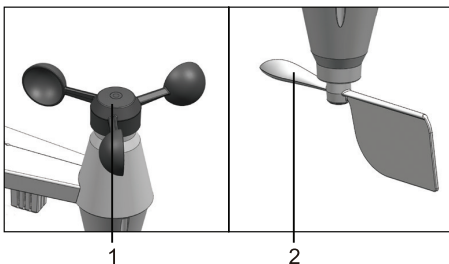

1. Wind cups anemometer
2. Wind vane

LCD DISPLAY

NORMAL TIME AND CALENDAR

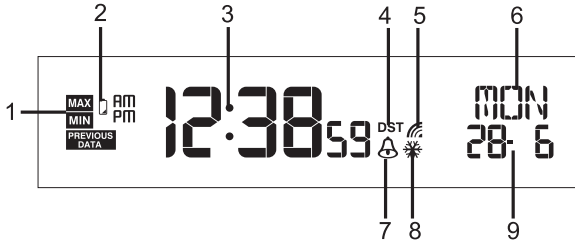

1. MAX/MIN
2. Low battery indicator for main unit
3. Time
4. DST
5. RCC Signal strength indicator
6. Day of the week
7. Alarm
8. Ice pre-alert "on"
9. Date

INDOOR TEMPERATURE AND HUMIDITY

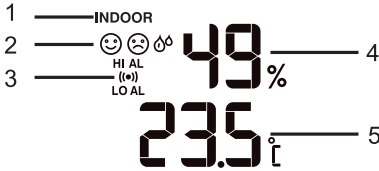

1. INDOOR
2. Comfort Zone
3. HI/LO Alert and Alarm
4. Indoor humidity
5. Indoor temperature

OUTDOOR TEMPERATURE AND HUMIDITY

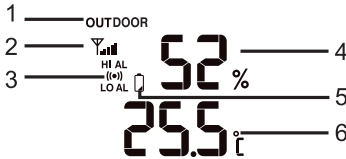

1. OUTDOOR
2. Outdoor signal strength indicator
3. HI/LO Alert and Alarm
4. Outdoor humidity
5. Low battery indicator
6. Outdoor temperature

WEATHER FORECAST



1. Weather forecast icon

BAROMETER

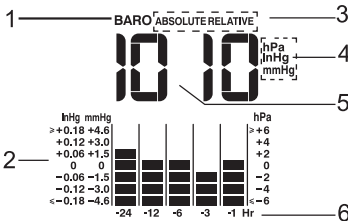

1. BARO indicator
2. HISTORY
3. ABSOLUTE/RELATIVE indicator
4. Barometer measurement unit (hPa/inHg/mmHg)
5. Barometer reading
6. Hourly records indicator

RAINFALL

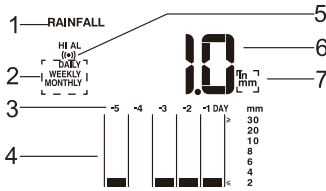

1. RAINFALL indicator
2. Time range record indicator
3. Day records indicator
4. HISTORY
5. Hi Alert and Alarm
6. Current rainfall rate
7. Rainfall unit (inch/mm)

WIND DIRECTION/WIND SPEED

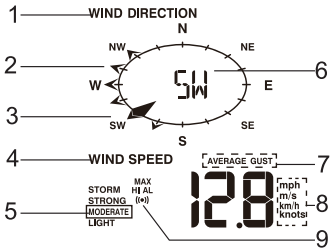

1. WIND DIRECTION indicator
2. Wind direction indicator during the last hour
3. Current wind direction indicator
4. WIND SPEED indicator
5. Wind levels
6. Current wind direction reading
7. AVERAGE/GUST wind indicator
8. Wind speed unit (mph/ m/s/ km/h/ knot)
9. Hi Alert and Alarm

WIND CHILL / HEAT INDEX / INDOOR DEW POINT



1. WIND CHILL/HEAT INDEX/ INDOOR DEW POINT indicator
2. Wind chill/ Heat index/ Indoor Dew point reading

INSTALLATION

WIRELESS 5-IN-1 SENSOR

Your wireless 5-IN-1 sensor measures wind-speed, wind-direction, rainfall, temperature and humidity for you.

It's fully assembled and calibrated for your easy installation.

BATTERY AND INSTALLATION

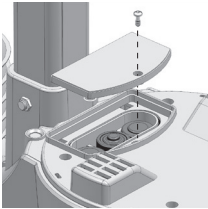

Unscrew the battery door at bottom of unit and insert the batteries according to the +/- polarity indicated. Screw the battery door compartment on tightly.

Note:

1. Ensure the water tight O-ring is properly aligned in place to ensure water resistant.
2. The red LED will begin flashing every 12 seconds.

Install the wireless 5-IN-1 sensor in an open location with no obstructions above and around the sensor for accurate rain and wind measurement. Install the sensor with the smaller end facing the North to properly orient the wind direction vane. Secure the mounting stand and bracket (included) to a post or pole, and allow minimum 1,5m off the ground.

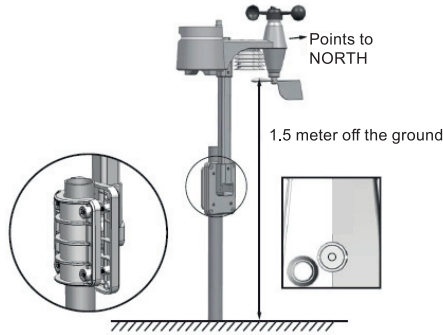

MOUNTING GUIDELINES

1. Install the wireless 5-IN-1 sensor at least 1.5m off the ground for better and more accurate wind measurements.
2. Choose an open area within 150 meters from the LCD display Main Unit.
3. Install the wireless 5-IN-1 sensor as level as possible to achieve accurate rain and wind measurements.
4. Mount the wireless 5-IN-1 sensor with the wind meter end pointing to the North to correctly orient direction of the wind vane.



Mounting on pole
(Pole Diameter 1"~1.3" (25~33mm))

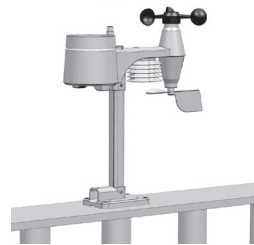

Mounting on the railing

DISPLAY MAIN UNIT

STAND AND BATTERIES INSTALLATION

The unit is designed for desktop or wall mount for easy viewing.



1. Remove the battery door of the main unit.
2. Insert a new button cell battery.
3. Replace the battery door.
4. Once the battery are inserted, all the segments of the LCD will be shown briefly before entering the radio-controlled time reception mode.
5. The RC clock will automatically start scanning for the radio-controlled time signal in 8 seconds.

Note:

1. If no display appears on the LCD after inserting the batteries, press **[RESET]** button by using a pointed object.
2. In some cases, you may not receive the signal immediately due to the atmospheric disturbance.

PAIRING OF WIRELESS 5-IN-1 SENSOR WITH DISPLAY MAIN UNIT

After insertion of batteries, the Display Main Unit will automatically search and connect the wireless 5-IN-1 sensor (antenna blinking).
Once the connection is successful, antenna mark and readings for outdoor temperature, humidity, wind speed, wind direction, and rainfall will appear on the display.

CHANGING BATTERIES AND MANUAL PAIRING OF SENSOR

- Whenever you changed the batteries of the wireless 5-IN-1 sensor, pairing must be done manually.
1. Change the batteries to new ones.
 2. Press **[SCAN]** button.
 3. Press **[RESET]** button on the sensor.

Note:

1. Pressing **[RESET]** button at bottom of wireless 5-IN-1 sensor will generate a new code for pairing purpose.
2. Always dispose old batteries in an environmentally safe manner.

RADIO CONTROLLED/ATOMIC CLOCK FUNCTION

When the unit receives RCC signal, a sync-time symbol  will appear on the LCD, and synchronizes daily.

Note:

1. The strength of radio-controlled time signal from the transmitter tower may be affected by geographical location or building around.
2. Always place the unit away from interfering sources such as TV set, computer, etc.
3. Avoid placing the unit on or next to metal plates.
4. Closed areas such as airport, basement, tower block, or factory are not recommended.

SIGNAL STRENGTH INDICATOR



The signal indicator displays signal strength in 4 levels. Wave segment flashing means time signals are being received. The signal quality could be classified into four types:

 or 	
No signal quality	Weak signal quality
	
Acceptable signal quality	Excellent signal quality

TIME SETTING

The unit automatically set itself accordingly to the Radio Controlled Clock signal it received. To set the clock/calendar manually, first disable the reception by holding the RCC button for 8 seconds.

TO MANUALLY SET THE CLOCK / TIME ZONE SELECTION

1. Press and hold **[CLOCK]** button  2 seconds until **12 or 24 Hr** flashes.
2. Use **[V]** button / **[^]** button to adjust, and press **[CLOCK]** button  to proceed to the next setting.
3. Press **[CLOCK]** button  again to step the setting items in this sequence: Hour format → Hour → Minute → Second → Year → Month → Date → Hour offset → Language → DST AUTO/OFF.

Note:



1. The unit will automatically exit setting mode if no button was pressed in 60 seconds.
2. The hour offset is for DCF and MSF version. Its range is between -23 and +23 hours.
3. **DST** (Daylight Saving Time) feature is set to Auto (factory set). The clock has been programmed to automatically switch when the daylight saving time is in effect. User can set the **DST** to **OFF** to disable the feature.

DISABLE / ENABLE RCC SIGNAL RECEPTION

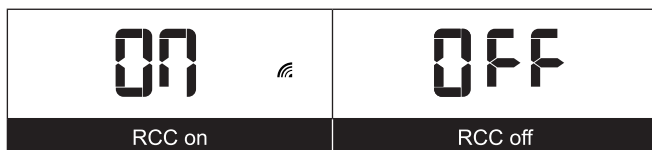
1. Press and hold the **RCC** button 8 seconds to disable the reception.
2. Press and hold the **RCC** button 8 seconds to enable automatic RCC reception.



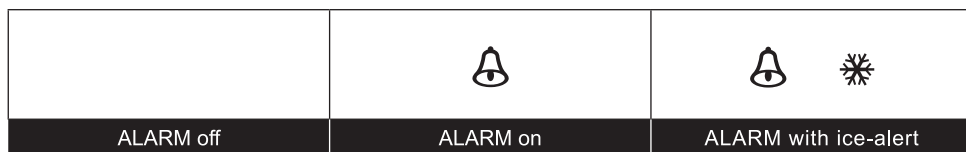

TO TURN ON/OFF ALARM CLOCK (WITH ICE-ALERT FUNCTION)

1. Press the **[ALARM]** button  anytime to show the alarm time.
2. Press the **[ALARM]** button  to activate the alarm.
3. Press again to activate alarm with ice-alert function.
4. To disable the alarm, press until the alarm icon disappears.



TO SET THE ALARM TIME

1. Press and hold the **[ALARM]** button  for 2 seconds to enter alarm setting mode **HOURL** will begin to flash.
2. Use **[V]** button / **[^]** button to adjust **HOURL**, and press the **[ALARM]** button  to proceed to set **MINUTE**.
3. Repeat 2 above to set **MINUTE**, and then press the **[ALARM]** button  to exit.







Note:

Pressing the **[ALARM]** button  twice when alarm time is being displayed will activate the temperature-adjusted pre-alarm.

The alarm will sound 30 minutes earlier if it detects outside temperature is below -3°C.

WEATHER FORECAST

The device contains sensitive pressure sensor built-in with sophisticated and proven software that predicts weather for the next 12 ~ 24 hours within a 30 to 50 km (19-31 miles) radius.

					
Sunny/Clear	Slightly Cloudy	Cloudy	Rainy	Rainy/Stormy	Snowy

Note:



1. The accuracy of a general pressure-based weather forecast is about 70% to 75%.
2. The weather forecast is meant for the next 12 hours, it may not necessarily reflect the current situation.
3. The icon  will flash on display when the rainstorm comes.
4. The **SNOWY** weather forecast is not based on the atmospheric pressure, but based on the outdoor temperature. When the outdoor temperature is below -3°C (26°F), the **SNOWY** weather indicator will be displayed on the LCD.

BAROMETRIC/ATMOSPHERIC PRESSURE

Press and hold the **[BARO]** button  for 2 seconds to toggle between:

- **ABSOLUTE** the absolute atmospheric pressure of your location
- **RELATIVE** the relative atmospheric pressure based on the sea

TO SET RELATIVE ATMOSPHERIC PRESSURE VALUE

1. Press and hold the **[BARO]** button  for 2 seconds until **ABSOLUTE** or **RELATIVE** icon flashes.
2. Press **[V]** button / **[^]** button to switch to **RELATIVE** mode.
3. Press the **[BARO]** button  once again until the **RELATIVE** atmospheric pressure digit flashes.
4. Press **[V]** button / **[^]** button to change the value.
5. Press the **[BARO]** button  to save and exit the setting mode.

Note:

1. The default relative atmospheric pressure value is 1013 hPa (29.91 inHg), which refers to the average atmospheric pressure.
2. When you change the relative atmospheric pressure value, the weather indicators will change along with it.
3. The relative atmospheric pressure is based on the sea level, but it will change with the absolute atmospheric pressure changes after operating the clock for 1 hour.

TO SELECT THE MEASUREMENT UNIT FOR THE BAROMETER

Use the **[BARO]** button  to change the unit between inHg/ mmHg/ hPa.





RAINFALL

TO SELECT THE RAINFALL DISPLAY MODE

The device displays how many mm/inches of rain are accumulated in an hour time period, based on current rainfall rate.

Press the **[RAINFALL]** button  to toggle between:

- **RATE** Current rainfall rate in past an hour
- **DAILY** The DAILY display indicate the total rainfall from midnight
- **WEEKLY** The WEEKLY display indicate the total rainfall from the current week
- **MONTHLY** The MONTHLY display indicate the total rainfall from the current calendar month

RAINFALL DAILY WEEKLY MONTHLY 	RAINFALL DAILY MONTHLY 	RAINFALL WEEKLY MONTHLY 	RAINFALL DAILY WEEKLY MONTHLY 
Rainfall rate	Daily rainfall	Weekly rainfall	Monthly rainfall

Note:



Rain rate is updated every 6 minutes, at every hour on the hour, and at 6, 12, 18, 24, 30, 36, 42, 48, 54 minute past the hour.

TO SELECT THE MEASUREMENT UNIT FOR THE RAINFALL

1. Press and hold the **[RAINFALL]** button  2 seconds to enter unit setting mode.
2. Use **[V]** button / **[^]** button to toggle between **mm** (millimeter) and **in** (inch).
3. Press the **[RAINFALL]** button  to confirm and exit.

WIND SPEED/WIND DIRECTION

TO READ THE WIND DIRECTION

Wind Direction Indicator	Meaning
	Real-time wind direction
	Wind directions appeared in last 5 minutes (max 6)

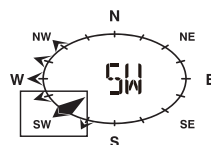

TO SELECT THE WIND DISPLAY MODE

Press the **[WIND]** button  to toggle between:





- **AVERAGE** The AVERAGE wind speed will display the average of all wind speed numbers recorded in the previous 30 seconds
- **GUST** The GUST wind speed will display the highest wind speed recorded from last reading



The wind level provides a quick reference on the wind condition and is indicated by a series of text icons.

Level	LIGHT	MODERATE	STRONG	STORM
Speed	2-8 mph 3-13 km/h	9-25 mph 14-41 km/h	26-54 mph 42-87 km/h	≥ 55 mph ≥ 88 km/h

TO SELECT WIND SPEED UNIT

1. Press and hold the  button for 2 seconds to enter unit setting mode.
2. Use  button /  button to change the unit between **mph** (miles per hour)/m/s (meter per second)/**km/h** (kilometer per hour)/**knots**.
3. Press the  button to confirm and exit.

WIND CHILL/HEAT INDEX/DEW-POINT

TO VIEW WIND CHILL

Press the **[INDEX]** button  repeatedly until **WIND CHILL** displays.

Note:

The wind chill factor is based on the combined effects of temperature and wind speed. The wind chill displayed is calculated solely from temperature and humidity measured from the 5-IN-1 sensor.

TO VIEW HEAT INDEX

Press the **[INDEX]** button  repeatedly until **HEAT INDEX** displays.

Heat Index range	Warning	Explanation
27°C to 32°C (80°F to 90°F)	Caution	Possibility of heat exhaustion
33°C to 40°C (91°F to 105°F)	Extreme Caution	Possibility of heat dehydration
41°C to 54°C (106°F to 129°F)	Danger	Heat exhaustion likely
≥55°C (≥130°F)	Extreme Danger	Strong risk of dehydration / sun stroke

Note:

Heat index is only calculated when temperature is 27° C (80° F) or above, and based solely from the temperature and humidity measured from the 5-IN-1 sensor.

TO VIEW DEW-POINT (INDOOR)

Press the **[INDEX]** button  repeatedly until **DEW POINT** displays.

Note:

The dew point is the temperature below which the water vapor in air at constant barometric pressure condenses into liquid water at the same rate at which it evaporates. The condensed water is called dew when it forms on a solid surface. The dew point temperature is calculated from the indoor temperature and humidity measured at the Main Unit.

HISTORY DATA (ALL RECORDS IN THE PAST 24 HOURS)

- The Display main unit automatically record and display data of past 24 hours on the hour.
- To check all the history data in the past 24 hours, press the **HISTORY** button.
- The LCD will display the past indoor and outdoor temperature & humidity, value of air pressure, wind chill, wind speed, rainfall and their time and date.

MAX/MIN MEMORY FUNCTION

1. Press the **MAX/MIN** button to check the maximum/minimum records. The checking orders will be: Outdoor max temperature → Outdoor min temperature → Outdoor max humidity → Outdoor min humidity → Indoor max temperature → Indoor min temperature → Indoor Max humidity → Indoor min humidity → Outdoor max wind chill → Outdoor min wind chill → Outdoor max heat index → Outdoor min heat index → Indoor max dew point → Indoor min dew point → Max pressure → Min pressure → Max average → Max gust → Max rainfall.
2. Press and hold the **[MAX/MIN]** button for 2 seconds to reset the maximum and minimum records.

Note:

When maximum or minimum reading is displayed, the corresponding timestamp will be shown.

HI/LO ALERT

HI/LO alert are used to alert you of certain weather conditions. Once activated, the alarm will turn on and amber LED starts flashing when a certain criterion is met. The following are areas and type of alert provided:

Area	Type of Alert available
Indoor temperature	HI and LO alert
Indoor humidity	HI and LO alert
Outdoor temperature	HI and LO alert
Outdoor humidity	HI and LO alert
Rainfall	HI alert *
Wind speed	HI alert

TO SET THE HI/LO ALERT

1. Press the **[ALERT]** button (🔔) until the desired area is selected.
2. Use **[V]** button / **[^]** button to adjust the setting.
3. Press the **[ALERT]** button (🔔) to confirm and continue to next setting.

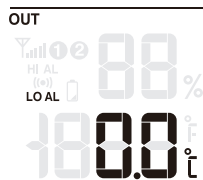
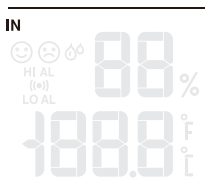
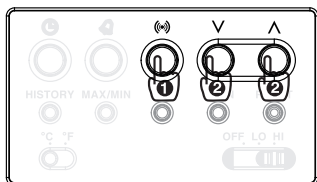

TO ENABLE / DISABLE THE HI / LO ALERT

1. Press the **[ALERT]** button (🔔) until the desired area is selected.
2. Press the **[ALARM]** button (🔔) to turn the alert on or off.

3. Press the **[ALERT]** button  to continue to next setting.

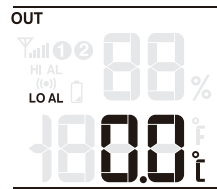
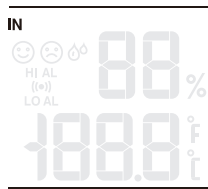
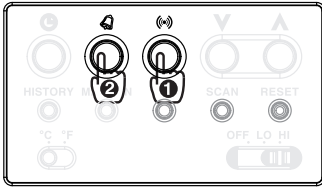

Note:

1. The unit will automatically exit setting mode in 5 seconds if no button is pressed.
2. When ALERT alarm is on, the area and type of alarm that triggered the alarm will be flashing and the alarm will sound for 2 minutes.
3. To silence the Alert alarm beeping, press the **[ALARM]** button , or let the beeping alarm automatically turn off after 2 minutes.

WIRELESS SIGNAL RECEPTION

				
No sensor	Signal searching	Strong signal	Weak signal	Signal lost

The 5-IN-1 sensor is capable of transmitting data wirelessly over an approximate operating of 150m range (line of sight). Occasionally, due to intermittent physical obstructions or other environmental interference, the signal may be weaken or lost. In the case that the sensor signal is lost completely, you will need to relocate the Display main unit or the wireless 5-IN-1 sensor.

TEMPERATURE & HUMIDITY

COMFORT INDICATION

The comfort indication is a pictorial indication based on indoor air temperature and humidity in an attempt to determine comfort level.

		
Too cold/too dry	Comfortable	Too warm/too humid

Note:



1. Comfort indication can vary under the same temperature, depending on the humidity.
2. There is no comfort Indication when temperature is below 0°C (32°F) or over 60°C (140°F).

DATA CLEARING

During installation of the wireless 5-IN-1 sensor, the sensors were likely to be triggered, resulting in erroneous rainfall and wind measurements. After the installation, user may clear out all the erroneous data from the Display Main Unit, without needing to reset the clock and re-establish pairing. Simply press and hold the **[HISTORY]** button for 10 seconds. This will clear out any data recorded before.

POINTING 5-IN-1 SENSOR TO THE SOUTH

The outdoor 5-IN-1 sensor is calibrated to be pointing to North by default. However, in some cases, users may wish to install the product with the arrow pointing towards the South:

1. First install the outdoor 5-IN-1 sensor with its arrow pointing to the South.
2. On the Display main unit, press and hold the **[WIND]** button  for 8 seconds until the upper part (Northern Hemisphere) of the compass lights up and blinking.
3. Use **[V]** button / **[^]** button to change to lower part (Southern Hemisphere).
4. Press the **[WIND]** button  to confirm and exit.



COLOURFUL BACKLIGHT DISPLAY

1. Slide **[OFF/HI/LO]** slide switch to the **[OFF]** position to turn off the backlight. Slide to the **[HI]** position for the brighter backlight. Slide to the **[LO]** position for the dimmer backlight.
2. Press **[LOOP]** key to enter the DEMO mode and the backlight changes the colour automatically.
3. Press **[RAINBOW]** key and the backlight will change its colour in this sequence: white → red → orange → yellow → green → cyan → blue → purple.
4. Press **[OUTDOOR TEMP]** key to enter the DEMO mode and the backlight changes the colour according to the outdoor temperature transmitted from the main unit. It has 17 backlight colours to display different temperature ranges.

	Temperature Range (°C)	Colour
1	≤ -20,0 °C	Dark Blue
2	-19,9 °C - 11,0 °C	Light Blue
3	-10,9 °C - 5,0 °C	Dark Aqua
4	-4,9 °C - 2,0 °C	Light Aqua
5	-1,9 °C - 1,0 °C	White
6	1,1 °C - 4,0 °C	Peak Green
7	4,1 °C - 8,0 °C	Green
8	8,1 °C - 12,0 °C	Yellow

9	12,1 °C - 16,0 °C	Light yellow
10	16,1 °C - 20,0 °C	Light orange
11	20,1 °C - 24,0 °C	Orange
12	24,1 °C - 28,0 °C	Light red
13	28,1 °C - 32,0 °C	Red
14	32,1 °C - 36,0 °C	Pink
15	36,1 °C - 40,0 °C	Light pink
16	40,1 °C - 45,0 °C	Purple
17	≥ 45,1 °C	Gray

(DCF&MSF version)

MAINTENANCE

TO CLEAN THE RAIN COLLECTOR

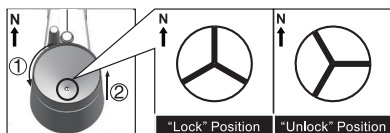





1. Rotate the rain collector by 30° anticlockwise.
2. Gently remove the rain collector.
3. Clean and remove any debris or insects.
4. Install all the parts when they are fully clean and dried.

TO CLEAN THE THERMO/HYGRO SENSOR

1. Unscrew the 2 screws at the bottom of the radiation shield.
2. Gently pull out the shield.
3. Remove carefully any dirt or insects inside the sensor casing (Do not let the sensors inside get wet).
4. Clean the shield with water and remove any dirt or insects.
5. Install all the parts back when they are fully clean and dried.

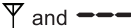
TROUBLESHOOTING

Problem / Symptom	Solution
Strange or no measurement of Rain Sensor	<ol style="list-style-type: none"> 1. Check the drain hole in the rain collector. 2. Check the balance indicator.
Strange or no measurement of Thermo / Hygro Sensor	<ol style="list-style-type: none"> 1. Check the radiation shield. 2. Check the sensor casing.
Strange or no measurement of Wind Speed and Direction	<ol style="list-style-type: none"> 1. Check wind cups (Anemometer). 2. Check the wind vane.

 and  (Signal lost for 15 minutes)	<ol style="list-style-type: none"> 1. Relocate the main unit and 5-in-1 sensor closer to each other. 2. Make sure the main unit is placed away from other electronic appliances that may interfere with the wireless communication (TVs, computers, microwaves). 3. If problem continues, reset both main unit and 5-in-1 sensor.
 and  (Signal lost for 1 hour)	

SPECIFICATIONS

MAIN UNIT

Dimensions (W × H × D)	136 × 168 × 24.5 mm
Weight	370g with batteries
Adapter	AC 4.5 V / 300 mA
Battery	Button cell CR2032
Support channels	Wireless 5-in-1 sensor (Wind speed, Wind direction, Rain gauge, thermo-hygro)

INDOOR BAROMETER

Barometer unit	hPa, inHg and mmHg
Measuring range	(540 to 1100 hPa) / (405 ~ 825 mmHg) / (15.95 ~ 32.48 inHg)
Resolution	1hPa, 0.01inHg, 0.1mmHg
Accuracy	(540 ~ 699hPa ± 8hPa @ 0~50°C) / (700 ~ 1100hPa ± 4hPa @ 0~50°C) (405 ~ 524 mmHg ± 6mmHg @ 0~50°C) / (525 ~ 825 mmHg ± 3mmHg @ 0~50°C) (15.95 ~ 20.66inHg ± 0.24inHg @ 32~122°F) / (20.67 ~ 32.48inHg ± 0.12inHg @ 32~122°F)
Weather forecast	Sunny / Clear, slightly Cloudy, Cloudy, Rainy, Rainy / Stormy and Snowy
Display modes	Current, Max, Min, Historical data for last 24hrs
Memory modes	Max & Min from last memory reset (with time stamp)

INDOOR TEMPERATURE

Temp. unit	°C or °F
Displayed range	-40°C to 70°C (-40°F to 158°F)
Operating range	-10°C to 50°C (14°F to 122°F)
Resolution	0.1°C or 0.1°F
Accuracy	+/- 1°C or 2°F typical @ 25°C (77°F)
Display modes	Current, Min and Max, Historical data for past 24 hours
Memory modes	Max & Min from last memory reset (with time stamp)
Alarm	Hi / Lo Temperature Alert

INDOOR HUMIDITY

Displayed range	20% to 90% RH (< 20%: LO; > 90%: HI) (Temperature between 0°C to 60°C)
Operating range	20% to 90%RH
Resolution	1%
Accuracy	+/-5% typical @ 25°C (77°F)
Display modes	Current, Min and Max, Historical data for past 24 hours
Memory modes	Max & Min from last memory reset (with time stamp)
Alarm	Hi / Lo Humidity Alert

RADIO-CONTROLLED / ATOMIC CLOCK

Synchronization	Auto or disabled
Clock display	HH:MM:SS / Weekday

Hour format	12hr AM/PM or 24hr
Calendar	DD/MM
Weekday in 5 languages	EN, FR, DE, ES, IT
Time signal	DCF, MSF
Hour offset	-23 to +23 hours (DCF and MSF versions only)
DST	AUTO / OFF

WIRELESS 5-IN-1 SENSOR

Dimensions (W × H × D)	343.5 × 393.5 × 136 mm
Weight	734g with batteries
Battery	3 × AA size 1.5V battery (Lithium battery recommended)
Frequency	868 MHz (European) / 915 MHz (North American)
Transmission	Every 12 seconds

OUTDOOR TEMPERATURE

Temp. unit	°C or °F
Displayed range	-40°C to 80°C (-40°F to 176°F)
Operating range	-40°C to 60°C (-40°F to 140°F)
Resolution	0.1°C or 0.1°F
Accuracy	+/- 0.5°C or 1°F typical @ 25°C (77°F)
Display modes	Current, Min and Max, Historical data for past 24 hours
Memory modes	Max & Min from last memory reset (with time stamp)
Alarm	Hi / Lo Temperature Alert

OUTDOOR HUMIDITY

Displayed range	1% to 99% (< 1%: LO; > 99%: HI)
Operating range	1% to 99%
Resolution	1%
Accuracy	+/- 3% typical @ 25°C (77°F)
Display modes	Current, Min and Max, Historical data for past 24 hours
Memory modes	Max & Min from last memory reset (with time stamp)
Alarm	Hi / Lo Humidity Aler

RAIN GAUGE

Unit for rainfall	mm and in
Range for rainfall	0~9999mm (0~393.7inches)
Resolution	0.4 mm (0.0157 in)
Accuracy for rainfall	Greater of +/- 7% or 1 tip
Display modes	Rainfall (Rate / Daily / Weekly / Monthly), Historical data for past 24 hours
Memory modes	Total rainfall from last memory reset
Alarm	Hi Rainfall Alert

WIND SPEED

Wind speed unit	mph, m/s, km/h, knots
Wind speed range	0~112mph, 50m/s, 180km/h, 97knots
Wind speed resolution	0.1mph or 0.1knot or 0.1m/s
Speed accuracy	< 5m/s: +/- 0.5m/s; > 5m/s: +/- 6%
Direction resolutions	16
Display modes	Gust/average wind speed & direction, Historical data for past 24 hours
Memory modes	Max gust speed with direction (with time stamp)
Alarm	Hi Wind speed Alert (Average / Gust)

ADAPTER TECHNICAL SPECIFICATIONS:

Manufacturer's name or trade mark, commercial registration number and address	HUA XU ELECTRONICS FACTORY, No. 1, Shi Tang Bei Street 2, Shi Jie Town, Dong Guan City, Guang Dong, P.R.China
Model identifier	HX0180450300A2E
Input voltage	AC230-240V
Input AC frequency	50Hz
Output voltage	AC4.5V
Output current	0.3A
Output power	1.35W
Average active efficiency	≥68.94%
Efficiency at low load (10 %)	≥62.15%
No-load power consumption	≤0.10W

INSTRUCTIONS AND INFORMATION REGARDING THE DISPOSAL OF USED PACKAGING MATERIALS

Dispose of packaging material at a public waste disposal site.

DISPOSAL OF USED ELECTRICAL AND ELECTRONIC APPLIANCES



The meaning of the symbol on the product, its accessory or packaging indicates that this product shall not be treated as household waste. Please, dispose of this product at your applicable collection point for the recycling of electrical & electronic equipment waste. Alternatively in some states of the European Union or other European states you may return your products to your local retailer when buying an equivalent new product. The correct disposal of this product will help save valuable natural resources and help in preventing the potential negative impact on the environment and human health, which could be caused as a result of improper liquidation of waste. Please ask your local authorities or the nearest waste collection centre for further details. The improper disposal of this type of waste may fall subject to national regulations for fines.

For business entities in the European Union

If you wish to dispose of an electrical or electronic device, request the necessary information from your seller or supplier.

Disposal in other countries outside the European Union

If you wish to dispose of this product, request the necessary information about the correct disposal method from local government departments or from your seller.



This product meets all the basic EU regulation requirements that relate to it.

Changes to the text, design and technical specifications may occur without prior notice and we reserve the right to make these changes.

The original version is in the Czech language.

Address of the manufacturer: FAST ČR, a.s., Černokostelecká 1621, Říčany CZ-251 01

Hereby, FAST ČR, a.s. declares that the radio equipment type SWS 9700 is in compliance with Directive 2014/53/EU. The full text of the EU declaration of conformity is available at the following internet address: www.sencor.com

SENCOR®

EN Warranty conditions

Warranty card is not a part of the device packaging.

This product is warranted for the period of 24 months from the date of purchase to the end-user. Warranty is limited to the following conditions. Warranty is referred only to the customer goods using for common domestic use. The claim for service can be applied either at dealer's shop where the product was bought, or at below mentioned authorized service shops. The end-user is obligated to set up a claim immediately when the defects appeared but only till the end of warranty period. The end user is obligated to cooperate to certify the claiming defects. Only completed and clean (according to hygienic standards) product will be accepted. In case of eligible warranty claim the warranty period will be prolonged by the period from the date of claim application till the date of taking over the product by end-user, or the date the end-user is obligated to take it over. To obtain the service under this warranty, end-user is obligated to certify his claim with duly completed following documents: receipt, certificate of warranty, certificate of installation.

This warranty is void especially if apply as follows:

- Defects which were put on sale.
- Wear-out or damage caused by common use.
- The product was damaged by unprofessional or wrong installation, used in contrary to the applicable instruction manual, used in contrary to legal enactment and common process of use or used for another purpose which has been designed for.
- The product was damaged by uncared-for or insufficient maintenance.
- The product was damaged by dirt, accident of force majeure (natural disaster, fire, and flood).
- Defects on functionality caused by low duality of signal, electromagnetic field interference etc.
- The product was mechanically damaged (e.g. broken button, fall).
- Damage caused by use of unsuitable media, fillings, expendable supplies (batteries) or by unsuitable working conditions (e.g. high temperatures, high humidity, quakes).
- Repair, modification or other failure action to the product by unauthorized person.
- End-user did not prove enough his right to claim (time and place of purchase).
- Data on presented documents differs from data on products.
- Cases when the claiming product cannot be indentified according to the presented documents (e.g. the serial number or the warranty seal has been damaged).

Authorized service centers

Visit www.sencor.com for detailed information about authorized service centers.