

# SENCOR®

SSI 0810VT



STEAM GENERATOR  
Translation of the original manual



# SENCOR®

SSI 0810VT



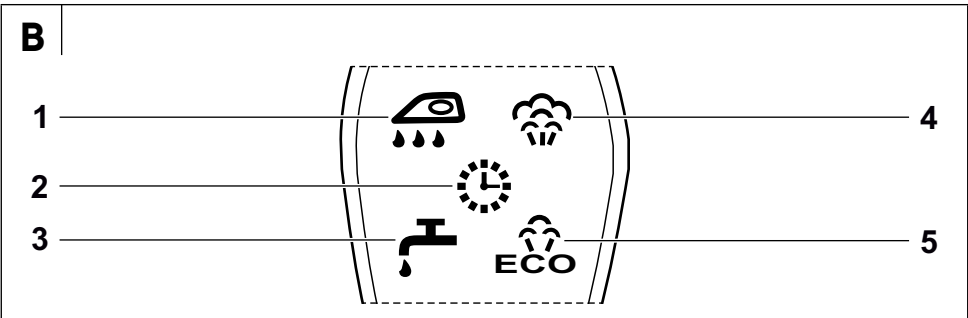
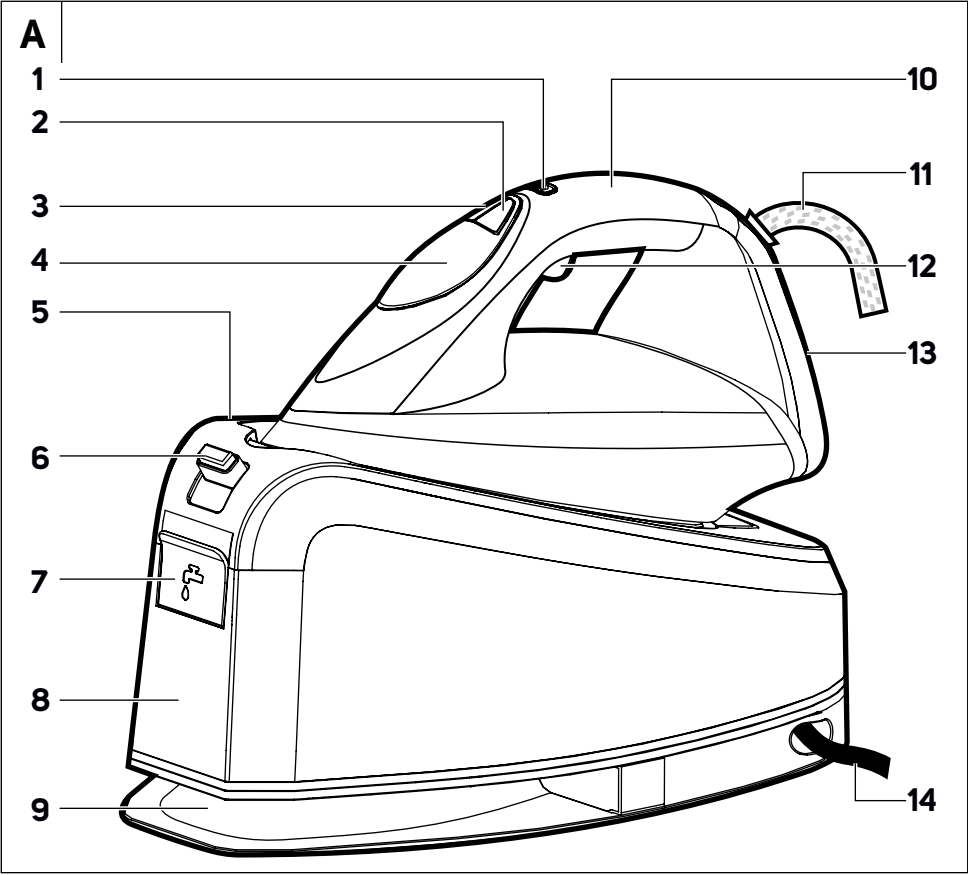

# EN Steam generator

## Important safety instructions

### **READ CAREFULLY AND STORE FOR FUTURE USE.**

- This appliance may be used by children 8 years of age and older and by persons with physical or mental impairments or by inexperienced persons, if they are properly supervised or have been informed about how to use the appliance in a safe manner and understand the potential dangers.
- Children must not play with the appliance. Cleaning and maintenance performed by the user must not be performed by unsupervised children.
- In the event that the power cord is damaged, have it repaired at a professional service centre to prevent causing a dangerous situation. It is forbidden to use the appliance if it has a damaged power cord.
- The iron must not be left without supervision when connected to mains power.
- Always disconnect the iron from the power socket when leaving it without supervision, when filling up or emptying the water tank and when you have finished using it.
- The water tank lid must not be open when ironing. The refilling of the water tank is described in the relevant chapter of this user's manual.



## Attention:

The surfaces of the iron may become hot during use.

### Electrical safety

- Before connecting the base unit to a power socket, make sure the voltage stated on its rating label corresponds to the voltage in your power socket.
- Connect the base unit only to a properly grounded socket. Do not use an extension cord.
- Do not touch the iron with wet or damp hands when it is connected to a power socket.
- To avoid potential injury by electrical shock, do not clean the iron or the base unit under running water, do not spray it with water and do not submerge it in water or any other liquid.
- Ensure that the power cord does not come into contact with water, moisture or a hot surface.
- Do not place heavy items on the power cord. Make sure the power cord does not hang over the edge of a table and that it is not touching a hot surface or sharp objects.
- Disconnect the base unit from the power socket by gently pulling the plug of the power cord, and not the power cord itself. Otherwise, this could damage the power cord or the socket.
- Do not pull or carry the base unit by the power cord. Do not pull the iron by the steam hose.
- To avoid the danger of injury by electrical shock, do not repair the iron or the base unit yourself or make any adjustments to it. Have all repairs performed at an authorised service centre. By tampering with the product you risk voiding your legal rights arising from unsatisfactory performance or quality warranty.
- If the power cord is damaged, have it replaced at a specialised service centre. It is forbidden to use the base unit if it has a damaged power cord or plug. Proceed in the same way in the event of a damaged steam hose.

### Safety during use

- This iron is designed for home use. Do not use it in industrial surroundings or outdoors.
- Do not place the iron on or near an electric or gas stove or other sources of heat.
- Never iron clothing on a body.
- Do not touch the hot ironing surfaces. Otherwise, this could cause burns.
- Never fill the water tank directly underneath a water tap. Always use a suitable container for filling the water tank. Never add vinegar, descaling agents or other additives to the water tank.
- Prior to cleaning or any other handling of the iron and the base unit, ensure that you have disconnected from the power socket, allow the soleplate to cool down.

- Prior to using this appliance, please read the user's manual thoroughly, even in cases, when one has already familiarised themselves with previous use of similar types of appliances. Only use the appliance in the manner described in this user's manual. Keep this user's manual in a safe place where it can be easily retrieved for future use. In the event that you hand this appliance over to somebody else, make sure to also include this user's manual.
- Carefully unpack the appliance and take care not to throw away any part of the packaging before you find all its parts. We recommend saving the original cardboard box, packaging material, purchase receipt and responsibility statement of the vendor or warranty card for at least the duration of the legal liability for unsatisfactory performance or quality. In the event of transportation, we recommend that you pack the appliance in the original box from the manufacturer.

### DESCRIPTION OF THE APPLIANCE

<b>A1</b> Main switch	<b>A7</b> Water tank filling hole cap
<b>A2</b> Calc Clean button for self cleaning to remove limescale deposits	<b>A8</b> Water tank
<b>A3</b> SET for switching between the high steam mode and the ECO mode with less steam	<b>A9</b> Power cord winding compartment
<b>A4</b> Display	<b>A10</b> Handle
<b>A5</b> Base unit	<b>A11</b> Steam hose
<b>A6</b> Lock/release iron from the base unit safety	<b>A12</b> Steam release button
	<b>A13</b> Standing surface
	<b>A14</b> Power cord

<b>B1</b> Iron descaling/cleaning indicator	<b>B4</b> Heating up/steam ironing indicator
<b>B2</b> Automatic iron shut-off indicator	Flashing – heating up
<b>B3</b> Low water level in tank indicator	Lit – temperature reached
	<b>B5</b> ECO mode indicator

### BEFORE FIRST USE

- Before first use, remove all packaging or protective materials including promotion stickers and labels from the iron and the base unit.
- Wipe the iron's soleplate with a lightly dampened cloth before first use and then wipe dry. Using a dry or lightly dampened cloth, also clean the outer parts of the iron and then wipe it dry.
- Clean the surface of the base unit using a soft cloth.



#### Attention:

Never submerge the iron and the power cord of the base unit in water or any other liquid!

### OPERATION

#### FILLING THE WATER TANK

- The water tank on the base unit is intended to be filled with tap water. Limescale deposits may quickly form if you live in an area with hard or very hard water. To extend the lifetime of the iron, it is recommended to mix the tap water with distilled water. The ratio of distilled water to tap water is as follows:
  - 1:1 for medium hard water
  - 2:1 for hard water
  - 3:1 for very hard water



#### Note:

Your local water utility will provide information about the water hardness in your area.



#### Attention:

Never add water softeners, vinegar, starch, descaling agents, perfumes or other additives to the water.

- Prior to filling the water tank with water, the base unit must be disconnected from the power socket and located on a stable and horizontal surface.
- Prepare a suitable container and fill it up with water. Tilt open the cap of the filling hole **A7** and slowly pour the water from the container into the filling hole of the water tank. Make sure that the water level does not rise above the maximum water level mark on the water tank.
- After filling the water tank, close the filling hole cap. In the event that you spilled any water while filling, thoroughly dry everything that is wet.

### TURNING ON

- Connect the power cord of the base unit to a power socket and press the main power switch **A1** on the iron. The indicator will be lit on the display which means that the iron is heating up. Once the iron's thermostat reaches the correct temperature, the indicator will remain permanently lit. The iron is now ready for use.



#### Note:

The iron is equipped with electronic temperature control, which enables the ironing of all types of fabrics that are suitable for ironing and in whatever order and without the need to set the temperature or garment class.

- To take the iron off the base unit, it is necessary to first release the iron by pushing the lock/release safety **A6** towards the open padlock symbol. The iron can be taken off the base unit before or after it is turned on.

### IRONING WITH STEAM



#### Attention:

In order to iron with steam, the water tank must be filled with a sufficient amount of water.

- The iron is equipped with the following two steam output intensity levels that are toggled using the **SET** button:



The ECO mode is intended for sufficient steam output for standard ironing with low power use; it uses less steam and saves power without affecting the ironing result.



This mode is intended for maximum steam output for demanding or vertical ironing.

- Press the **SET** button to select the steam mode or and wait until the indicator of the selected mode remains permanently lit.
- Holding down button **A12** on the iron will start releasing steam while ironing.
- If you wish to stop releasing steam, **release the steam** button.

- We recommend to select  mode for all standard ironing tasks. Only when ironing linen fabrics, strong silk or similar fabrics is it recommended to select the  mode.

## IRONING WITH VERTICAL STEAM

- The iron can also be used when ironing hanging textiles (e.g. curtains, garments hanging on coat hangers, etc.).
- Use the **SET** button to select mode  and wait until the indicator remains permanently lit.
- Position the iron into a vertical position. Use one hand to gently tension the fabric and vertically move the iron from bottom up and press button **A12** to release steam.



### Warning:

Never point the current of steam at persons or animals. Never attempt to remove creases from garments that somebody is wearing.

## PUTTING THE IRON ASIDE WHILE IRONING

- During the ironing process, you can put the iron aside on its standing surface **A13** or on the base unit.

## OTHER FUNCTIONS

### Detection of absence of water

- In the event that the water level in the water tank declines below the maximum water level during the ironing process, the indicator  will start flashing and the pump inside the base unit will automatically shut off. This will prevent damaging the base unit and extend the lifetime of the appliance. In such a case, disconnect the base unit from the power socket and add water as described in chapter FILLING THE WATER TANK.

## DRIP-STOP SYSTEM

- The iron is equipped with the Drip-Stop system, which automatically stops water supply when the set temperature is insufficient for generating steam and thereby prevents potential dripping of hot water out of the steam outlets.

### Automatic shut-off

- If you leave the iron idle for 10 minutes or do not press any button, the iron will beep 6x and then shut itself off automatically. The indicator  will light up on the display.



### Attention:

Despite the iron being equipped with an automatic shut-off function, for safety reasons, never leave it without supervision when it is connected to a mains power socket.

- If the iron has automatically shut itself off, hold down the power switch to turn it off completely. Then turn it on again using the power switch.
- If the iron has automatically shut itself off, hold down the power switch to turn it off completely. Then turn it on again using the power switch.

## TIPS FOR QUALITY IRONING

- Follow the ironing instructions for each individual garment. Only iron colourfast and heat resistant laundry. We recommend ironing laundry with a print turned inside out.
- Never iron over places that have sweat marks or other stains. The high temperature fixes the stain in place, making it difficult to remove.
- To avoid silk, wool and synthetic fabrics from being shiny after ironing, iron them from the underside.
- Some materials are easier to iron when they are lightly damp.

- Spray fine fabrics before ironing them or iron them under a lightly dampened wiping cloth. You can also hold the iron approx. 2 cm above the laundry and use the ECO steam release mode.
- Iron very crumpled garments in the high steam mode.

## TURNING OFF

- Turn off the iron by pressing the main power switch **A1**, stand it on the base unit or on its back standing surface and disconnect the power cord from the power socket. Allow the iron to cool down.
- After the iron has cooled down completely, clean it according to the instructions in chapter CLEANING AND MAINTENANCE.
- Place the iron on the base unit and secure it in place by pushing the lock/release safety **A6** towards the closed padlock symbol.

## CLEANING AND MAINTENANCE

### Cleaning After Every Use





### Attention:

Before cleaning, the base unit must be disconnected from the power socket and cooled down. When cleaning, do not submerge the iron or the power cord of the base unit in water or any other liquid.

- Open the cap of the water tank filling hole and empty out any remaining water above a sink. Close the cap.
- In the event that the soleplate or the surface of the iron is dirty, wipe with a lightly dampened cloth and then wipe dry.
- For cleaning, do not use steel wool, solvents or cleaning products with an abrasive effect, etc. to prevent damaging the surface being cleaned.

## REMOVING LIMESCALE DEPOSITS

- For the removal of limescale deposits from the inner part of the soleplate, the iron is equipped with a self cleaning function. When the  indicator starts flashing on the display, it is necessary to clean the iron as soon as possible in the following procedure.
- Fill the water tank with clean water up to the maximum water level mark. Connect the base unit to a power socket and after releasing the lock/release safety **A6** (if it was locked), take the iron off the base unit.
- Turn the iron on using the main power switch and wait until the indicator  is lit on the display.
- Hold the iron in a horizontal position above the sink. Hold down the **Calc Clean** button. Steam and hot water will start to be released from the soleplate. At the same time also limescale deposits from the inner parts of the soleplate will be removed. Tilt the iron from side to side several times until the water tank is completely emptied out. After emptying it out, release the **Calc Clean** button and turn off the iron using the main power switch.
- Disconnect the base unit from the power socket and allow the iron to cool down. After it has cooled down, place it on the base unit and secure it in place using the lock/release safety **A6**.

## STORAGE

- When you have finished ironing and cleaning the iron according to the chapter above, wind the power cord into the bottom part of the base unit.
- Secure the iron on the standing surface of the base unit.
- Place the complete steam generator in a suitable location so that it cannot be tipped over.



### Attention:

Keep the stored steam generator away from extreme temperatures, direct sunlight and excessive humidity and do not store it in an overly dusty environment. Do not place any items on to the stored steam generator.

## TECHNICAL SPECIFICATIONS

Rated voltage range.....	220–240 V AC
Rated frequency.....	50/60 Hz
Rated power input.....	2,000 – 2,400 W
Heating up time (approximately).....	35 s
Continuous steam output in the ECO mode.....	30 ± 5 g/min
Continuous steam output in the high steam mode.....	60 ± 5 g/min
Water tank capacity .....	1.5 l
Dimensions of the base unit (length × width × height) .....	323 mm × 194 mm × 60 mm
Dimensions of the iron (length × width × height) .....	275 mm × 124 mm × 131 mm
Weight .....	2,850 g
.....	.....

## INSTRUCTIONS AND INFORMATION REGARDING THE DISPOSAL OF USED PACKAGING MATERIALS

Dispose of used packaging material at a site designated for waste in your municipality.

## DISPOSAL OF USED ELECTRICAL AND ELECTRONIC EQUIPMENT



This symbol on products or original documents means that used electric or electronic products must not be added to ordinary municipal waste. For proper disposal, renewal and recycling, hand over these appliances to determined collection points. Alternatively, in some European Union states or other European countries you may return your appliances to the local retailer when buying an equivalent new appliance. Correct disposal of this product helps save

valuable natural resources and prevents potential negative effects on the environment and human health, which could result from improper waste disposal. Ask your local authorities or collection facility for more details. In accordance with national regulations penalties may be imposed for the incorrect disposal of this type of waste.

### For business entities in European Union states

If you want to dispose of electric or electronic equipment, ask your retailer or supplier for the necessary information.

### Disposal in other countries outside the European Union.

This symbol is valid in the European Union. If you wish to dispose of this product, request the necessary information about the correct disposal method from the local council or from your retailer.



This product meets all the basic requirements of EU directives related to it.



