

# SENCOR®

STM 7870GG / STM 7871GR / STM 7872BL  
STM 7873VT / STM 7874RD / STM 7875RS  
STM 7876GD / STM 7877CH / STM 7878BK

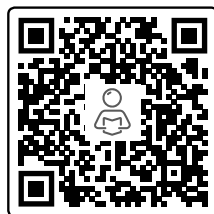

## **EN ■ Food Processor**

*Translation of the original manual*

**READ CAREFULLY AND STORE FOR FUTURE USE.**

- This appliance may be used by children 8 years of age and older and by persons with physical or mental impairments or by inexperienced persons, if they are properly supervised or have been informed about how to use the product in a safe manner and understand the potential dangers.
- Children must not use this appliance or play with it. Keep this appliance and the power cord out of reach of children.
- Before connecting this appliance to a power socket, make sure the rated voltage stated on its rating label corresponds to the voltage in your power socket.
- Never use accessories, which have not been supplied with this appliance or which have not been explicitly recommended by the manufacturer for this type of appliance.
- This appliance is designed for household use. Do not use it for commercial purposes, in industrial surroundings, or outdoors, or for purposes other than those for which it is intended.
- Always place the appliance on an even, dry and stable surface. Do not place it on an electric or gas stove, in the vicinity of an open flame or appliances that are sources of heat.



Do not put your hands into an area marked by this symbol. Otherwise injury could result when the multi-function head is tilted out and is not properly locked in the top position.

- Never use multiple attachments at the same time.

- Before putting the appliance into operation, check that it is correctly assembled and that the multi-function head is tilted down in the horizontal position. For safety reasons, this appliance is equipped with a safety mechanism that prevents the motor from being started when the multi-function head is tilted out.
- In the event that the multi-function head tilts out during operation, the appliance will automatically stop running. When the multi-function head is tilted to the horizontal working position, the appliance will not automatically resume operation. To start it again, it is necessary to press button **A18** on the display.
- Do not touch rotating parts of the appliance and ensure that foreign items such as clothing, hair, etc. are kept away. An injury could occur or the appliance could be damaged.
- In the event that an item, such as a spoon, falls into the bowl during operation, immediately set the speed control knob to the OFF position (stand-by mode), and disconnect the power cord from the power socket. Wait until the rotating parts come to a stop and then remove the item.
- If ingredients stick to the attachment or the sides of the bowl, turn the appliance off, disconnect it from the power socket, and wait until the rotating parts come to a stop. Use a silicone spatula to clean the attachment and the inside of the bowl. Then you can restart the appliance.
- Make sure that no hair, clothing or other items enter the feed tube of meat grinder while it is running. Do not put anything other than the ingredients that are to be processed into the feed tube.

- Never use your fingers or other items to push ingredients through the meat grinder feed tube. For this purpose there is a pusher included as an accessory.



**Warning:**

Incorrect use may lead to injuries.

- To prevent injury caused by sharp edges, be especially careful when handling the grinding blade of the meat grinder and the blade assembly of the blender. Increased attention must also be paid when emptying out the blending jar, when removing the blade assembly from the blending jar, when removing the grinding blade from the chamber, and when cleaning the appliance.
- Do not attempt to grind bones, nut shells or other hard ingredients.
- Hot liquids up to a temperature of 55 °C may be processed in the blending jar. Be especially careful when handling hot liquids. Hot steam or splashing hot foods and liquids may cause scalding. Never start the blender without the lid properly seated in position. When processing hot liquids, do not remove the inner cap during operation. Do not touch the hot surface. Use the handle to carry the blending jar when it is hot.
- The maximum continuous operating time is 10 minutes. Do not exceed the maximum operating time of 5 minutes when in the kneading mode and do not exceed the maximum operating time of 2 minutes when using the blender. Before starting it again, allow the appliance to cool down for 30 minutes.
- Always turn off the appliance, disconnect it from the power socket when not be using it, when leaving it without supervision, and before assembling, disassembling, cleaning or moving it. Prior to disassembling the appliance and replacing accessories

or accessible parts that move during use, wait until all moving parts come to a stop.

- Clean it according to the instructions in chapter Cleaning and maintenance.
- Never wash the appliance under running water or submerge it in water or another liquid.
- Do not turn on the appliance when it is empty. Incorrect use of the appliance may negatively affect its lifetime.
- Ensure that the power plug contacts do not come into contact with water or moisture. Do not place heavy items on the power cord. Make sure that the power cord does not hang over the edge of a table or that it is not touching a hot surface.
- Disconnect the power cord from the power socket by pulling on the plug, never pulling on the cord. Otherwise, this could damage the power cord or the socket.
- If the power cord is damaged, have it replaced at a professional service centre. It is forbidden to use the appliance if it has a damaged power cord.
- To avoid the danger of injury by electrical shock, do not repair the appliance yourself or make any adjustments to it. Have all repairs performed at an authorised service centre. By tampering with the appliance, you risk voiding your legal rights arising from unsatisfactory performance or quality warranty.

**A**

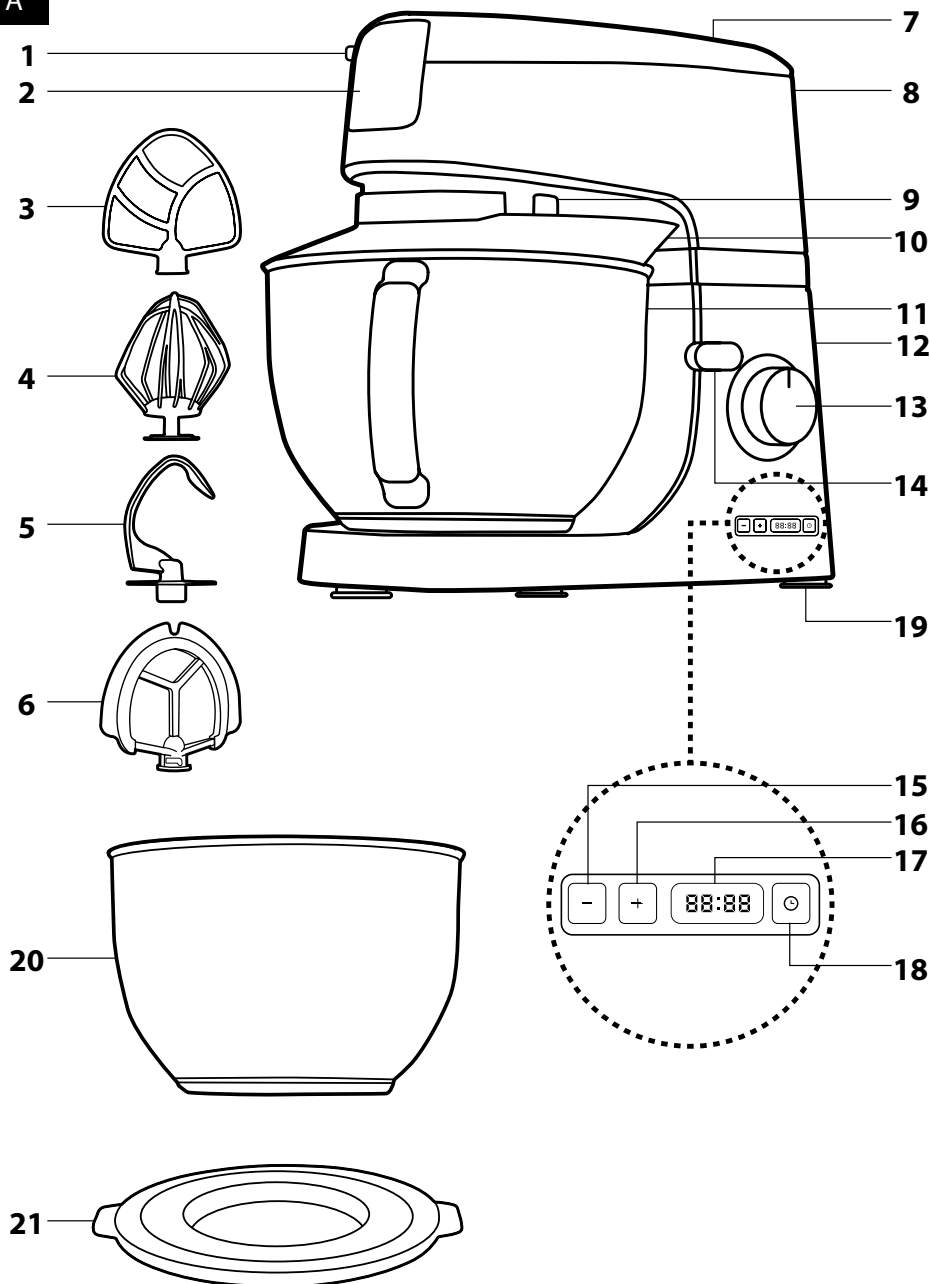

**B**

1

2

3

4

5

6

7

8

9

10

11

12

13

14

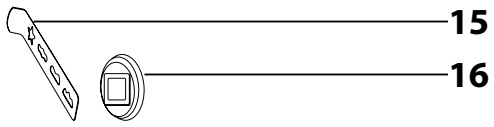
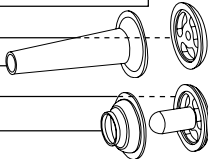
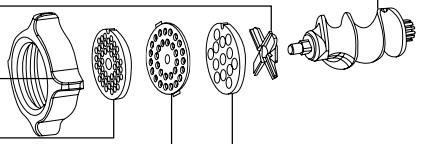
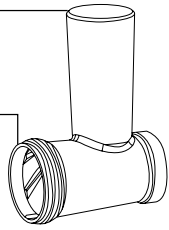
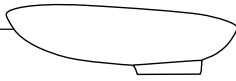
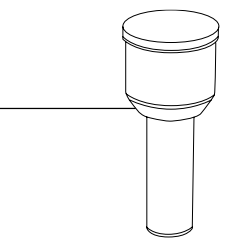

**C**

1

2

3

4

5

6

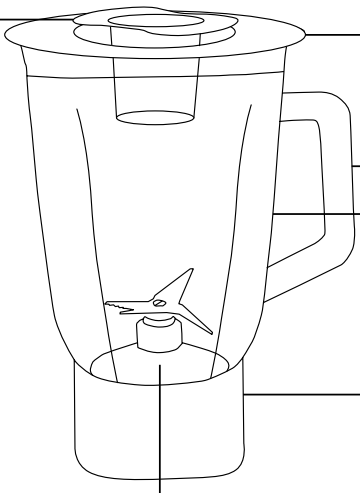

# EN Food Processor

## User's manual

- Prior to using this appliance, please read the user's manual thoroughly, even if you already have experience in using similar appliances. Only use the appliance in the manner described in this user's manual. Keep this user's manual in a safe place where it can be easily retrieved for future use.
- We recommend saving the original cardboard box, packaging material, purchase receipt and responsibility statement of the vendor or warranty card for at least the duration of the legal liability for unsatisfactory performance or quality. In the event of transportation, we recommend that you pack the appliance in the original box from the manufacturer.

### DESCRIPTION OF THE APPLIANCE AND ACCESSORIES

- A1** Button for releasing the meat grinder from the front attachment hub
- A2** Removable cover of the front meat grinder attachment hub
- A3** A-shaped beater
- A4** Balloon whisk
- A5** Kneading hook
- A6** Elastic A-shaped beater
- A7** Removable cover of the top blender attachment hub
- A8** Tilt-out multi-function head
- A9** Attachment hub for attaching attachments **A3-A6**
- A10** Transparent bowl cover with a hole for adding ingredients
- A11** 4.5-litre stainless steel bowl with handle
- A12** Base unit
- A13** Speed control knob serves to variably set the speed level MIN-1-2-3-4-5-6-MAX, sets the pulse level (PULSE) and turns the appliance off (OFF).
- A14** Multi-function head release lock
- A15** Minus,-" button for decreasing time
- A16** Plus,+ " button for increasing time
- A17** Display
- A18** Start/Pause button
- A19** Anti-slip feet for stability of the appliance during operation
- A20** 3-litre stainless steel bowl without handles
- A21** Lid serves to close the stainless steel bowl **A11** for short term storage of processed ingredients.

### DESCRIPTION OF MEAT GRINDER ACCESSORIES

- B1** Pusher
- B2** Stainless steel hopper
- B3** Feed tube
- B4** Grinding chamber
- B5** Screw shaft
- B6** Grinding blade
- B7** Screw ring
- B8** Fine grinding plate
- B9** Medium fine grinding plate
- B10** Coarse grinding plate
- B11** Separator
- B12** Sausage stuffer attachment
- B13** Moulder
- B14** Conical attachment
- B15** Cookie maker
- B16** Cookie maker holder



#### Note:

Parts **B11-B14** are contained inside the pusher **B1**. Certain models are only equipped with a fine and coarse grinding disc **B8** and **B10**.

### DESCRIPTION OF THE BLENDER ACCESSORIES

- C1** Inner cap of the blending jar
- C2** Outer lid of the blending jar with a hole for adding ingredients
- C3** Handle
- C4** 1.5-litre Tritan blending jar with titanium blades
- C5** Cuff
- C6** Blade assembly

### BEFORE FIRST USE

1. Take the appliance and its accessories out of the packaging materials.
2. Thoroughly wash all accessory parts that are intended to come into contact with food using warm water and a neutral kitchen detergent. Then rinse under clean running water and thoroughly wipe dry with a fine wiping cloth or allow them to dry naturally. After washing and drying, we recommend to coat the grinding blade **B6** and the grinding plates **B8-B10** with cooking oil.
3. Do not submerge the food processor or its power cord in water or any other liquids.



#### Attention:

The metal parts of the meat grinder and attachments **A3-A6** are not intended for washing in a dishwasher. Other removable parts may be washed in a dishwasher.

### BEATING, WHIPPING AND KNEADING

#### SELECTING ATTACHMENT TYPES

Attachment type	Purpose of use
Beater <b>A3</b> and <b>A6</b>	It is used for beating light and medium heavy yeast-free doughs, for preparing sauces, creams, fillings, etc. <b>Do not use it for kneading heavy doughs.</b>
Balloon whisk <b>A4</b>	It is used for whisking whole eggs or egg whites, whipped cream, foamy creams, etc. <b>Do not use it for beating or kneading doughs.</b>
Kneading hook <b>A5</b>	It is used for kneading various types of doughs including heavy and thick doughs such as for example bread dough, pizza dough, fresh pastry doughs, etc.

### ASSEMBLING AND DISASSEMBLING THE FOOD PROCESSOR

- Before you start assembling or disassembling the food processor, check that it is turned off and disconnected from the el. power socket.

#### 1. Inserting the bowl and attaching the cover

- 1.1 Place the food processor on an even, dry and stable surface, for example on a kitchen countertop.
- 1.2 Use the lock **A14** to release the multi-function head **A8** and tilt it out all the way. After tilting out the multi-function head release the lock **A14**. Locking of the multi-function head in the top open position is indicated by the lock returning to the default position, which is accompanied by an audible click.
- 1.3 Insert the stainless steel bowl **A11** into the base unit **A12** and secure it in place by turning it clockwise. When the bowl is properly attached, it cannot be separately lifted out of the base unit.
- 1.4 On to the bottom part of the multi-function head **A8** with attachment hub **A9**, slide the cover **A10** so that the latches along the perimeter of the round opening in the cover **A10** slide into the grooves along the perimeter of the attachment hub **A9**.
- 1.5 The lid **A21** is used for covering the bowl **A11** for short term storage of processed ingredients.

#### 2. Mounting attachments

- 2.1 When attaching an attachment, the multi-function head **A7** must be locked in the open position, see point 1.2 in the previous chapter. To attachment hub **A8**, attach one of the attachments **A3-A5** in such a way that the attachment hub shaft **A8** slides into the attachment. Push the attachment towards the attachment hub **A8** and turn it anticlockwise to secure it in place. Lightly pull the attachment downwards with one hand to check that it is properly attached.
- 2.2 Place the ingredients that you wish to process into the bowl **A11**. Release the lock **A14** and tilt the multi-function head **A8** to a horizontal position. After tilting down the multi-function head **A7**, release the lock **A13**. The locked status of the multi-function head in the tilted down work position is indicated by the lock returning to the default position. This is accompanied by an audible click.

#### 3. Disassembly

- 3.1 Use the lock **A14** to release the multi-function head **A8** and tilt it out all the way. After tilting out the multi-function head, release the lock. Locking of the multi-function head in the top open position is indicated by the lock returning to the default position, which is accompanied by an audible click.
- 3.2 Push the attachment towards the attachment hub **A9** and turn it clockwise to release it, and then remove it. Turn the bowl **A11** anticlockwise and remove it from the base unit **A12**. Remove the cover **A10** by pulling it downwards. Move the multi-function head **A8** back to the horizontal position.

### USING THE FOOD PROCESSOR

1. Select the right type of attachment based on its intended use and assemble the appliance according to the instructions in the chapter Assembling and disassembling the appliance. Place the ingredients into the bowl **A11**.



#### Attention:

In a single batch, it is possible to process no more than 2.2 litres of light dough or 0.8 litres of thick, heavy dough. The maximum number of egg whites that can be whisked at once is 12. We recommend that you do not fill the bowl **A11** past the level of the 3l mark. If an insufficient amount of ingredients are put in the bowl **A11** (less than 0.3 litres of dough), then they may not be optimally processed.

2. Make sure that the multi-function head **A8** is tilted down in the horizontal working position and that the speed control knob **A13** is set to the OFF position. Connect the power cord to a power socket.
3. Set the required speed using the speed control knob **A13**. Gradually turn the speed control knob **A13** clockwise to increase the speed, turning it in the opposite direction will reduce the speed. To initially stir in the ingredients, first set a lower speed and then adjust it as required. Electronic speed regulation ensures that the set speed will be maintained under various loads. While it is running, ingredients may be added into the bowl **A11** through the hole in the cover **A10**.
4. The pulse mode is used for increasing the speed to maximum for a short time. To activate the pulse mode, turn the speed control knob **A13** to the PULSE position and to ensure continuous operation hold it down in this position. As soon as you release the speed control knob **A13**, it will automatically return to the OFF position.
5. If it is necessary to wipe ingredients off the inside of the mixing bowl **A11** and the attachment, first turn off the food processor by setting the speed control knob **A13** to the OFF position and then disconnect it from the power socket. Wait until the rotating parts come to a stop and only then scrape away the ingredients with a spatula.
6. After you have finished using the appliance, set the speed control knob **A13** to the OFF position and disconnect the power cord from the power socket.
7. Wait until the rotating parts come to a stop and disassemble the food mixer according to the instructions included in chapter Assembling and disassembling the appliance. Use a soft plastic spatula to empty out the contents of the bowl **A11**.
8. Clean out the food processor after each use according to the instructions in chapter Cleaning and maintenance.

#### LED LIGHT

- The multi-function head **A8** has a LED light that turns on automatically when the food processor is connected to a power socket. The LED light turns off automatically after 2.5 minutes of inactivity, i.e. when the appliance is not running or when the speed is not set during this time. The LED light turns on again automatically when the food processor is put into operation by the control knob **A13** being set to a desired speed level. DISPLAY



- The appliance is equipped with a display **A14** that shows either the time that the food processor has been running (count-up function) or shows the remaining operating time (countdown function). The display is automatically lit when the food processor is connected to a power socket and remains lit even after the LED light turns off when no action is performed.

#### OPERATION WITH ELAPSED TIME DISPLAYED

- After setting one of the speed levels using the speed control knob **A13**, the food processor will start and the display **A17** will automatically show the operating time in one second intervals.
- Pressing button **A18** will stop the food processor and the counting up of time. The current elapsed operating time of the food processor will remain shown on the display. Pressing button **A18** again will start the food processor and time will continue counting up.
- Setting the speed control knob **A18** to the OFF position will stop the food processor and the time on the display will reset to zero (00:00).
- In the event that the multi-function head **A8** is tilted open or the cover of the top blender attachment hub **A7** is removed, while the food processor is running, then it will stop and the current elapsed time will flash on the display. To continue processing food and counting up the time, first tilt down the multi-function head **A8** into the working position or put the cover **A7** back on, and then press button **A18**.



#### Note:

In the event that the food processor runs continuously for 30 minutes, it will stop automatically. The LED light will remain lit and the operating time will flash.

#### OPERATION WITH COUNTDOWN

- If you wish to use the food processor with the countdown function, it is necessary to first set the time for which the food processor will run and after which it will stop automatically.



#### Note:

The maximum time that can be set on the display is 30 minutes.

- If you wish the food processor to run for up to 10 minutes (time range 00:03 s – 10:00 min) then set the required time using button **A16**. Each time the button is pushed, the time will increase in 30-second increments. If you wish to reduce the countdown time, press button **A15**. The time will be reduced in 30-second increments.
- If you want the food processor to run for a longer time, i.e. from 10 to 30 minutes (time range 10:00 – 30:00 min), then set the required time using button **A16**. Each time the button is pressed, the time will increase in 1-minute increments. If you wish to reduce the countdown time, press button **A15**. The time will be reduced in 1-minute increments.



#### Tip:

When the time 00:00 is shown on the display, then pressing button **A15** will set the time to 30 minutes (30:00).

- After setting one of the speed levels using the speed control knob **A13**, the food processor will start and at the same time, the time on the display **A17** will countdown in one-second intervals.
- Pressing button **A18** will stop the food processor and the countdown. The remaining operating time of the food processor will remain shown on the display. Pressing button **A18** again will start the food processor and time will continue counting down.
- In the event that the multi-function head **A8** is tilted open or the cover of the top blender attachment hub **A7** is removed, while the food processor is running, then it will stop and the remaining time will flash on the display.
- To continue processing food and counting down the time, first tilt down the multi-function head **A8** into the working position or put the cover **A7** back on, and then press button **A18**.

#### SETTING THE TIME TO ZERO

- If you wish to set the countdown time to zero without having to turn off the food processor, simultaneously press buttons **A15** and **A18**. The time will reset to 00:00.

#### QUICK GUIDE TO PROCESSING INGREDIENTS

Attachment type	Ingredients	Maximum load	Processing time	Speed selection
Balloon whisk <b>A4</b> and <b>A6</b>	Egg whites	12 pcs	4 min	5–6
Balloon whisk <b>A4</b> and <b>A6</b>	Whipping cream	1 l	6–8 min	5–6
Beater <b>A3</b>	Cake dough	2.2 l	6 min	3–4
Kneading hook <b>A5</b>	Bread dough Pizza dough	0.8 l	4–5 min	MIN to 2



#### Note:

The above processing times are only a reference.

When whipping egg whites, the bowl **A11** and the beater **A4** or **A6** must be perfectly clean and dry. Even a small amount of fat may cause the egg whites not to be whipped to the desired snowy consistency. Whipping cream should be cooled to a temperature of 6 °C prior to being whipped.

Prior to processing them, allow the ingredients used for making various doughs to rest at room temperature.

## GRINDING MEAT, MAKING SAUSAGES AND KEBABS, AND MAKING COOKIES

#### ASSEMBLING AND DISASSEMBLING THE MEAT GRINDER

- Insert the screw shaft **B5** into the grinding chamber **B4** with the cogged wheel entering first.
- Place the grinding blade **B6** on to the shaft **B5** (with the edge facing outwards from the chamber) and on to it attach a grinding plate **B8**, **B9** or **B10** depending on the preferred grind. Make sure that the notch in the grinding chamber **B4** slides into the groove in the grinding plate.



#### Attention:

When attaching the blade **B6**, be very careful not to injure yourself on the sharp edge.

- Place the screw ring **B7** on to the grinding chamber **B4** and tighten it securely by screwing it clockwise. Place the stainless steel hopper **B2** on to the feed tube **B3**.
- Make sure that the food processor is turned off and disconnected from the power socket. The multi-function head **A8** must be tilted down in the horizontal position and the whisk, beater or kneading attachments must be removed. Remove the front cover **A2** from the multi-function head **A8**. Place the assembled attachment against the attachment hub so that the feed tube **B3** is tilted to the right at an angle of approximately 45° from the vertical axis and secure the attachment in vertical position by turning it anticlockwise. The attachment is locked in place when the button **A1** slides out. This is accompanied by an audible click.
- When disassembling the meat grinder, first remove the hopper **B2**. Then press the button **A1** and remove the meat grinder by turning it clockwise. After removing the grinder, put the cover **A2** back in its place.
- When disassembling the meat grinder into its individual parts, proceed in the reverse sequence.

#### USING THE MEAT GRINDER

- First prepare the meat for grinding in the following way. Remove all bones, tendons, cartilage and cut the meat into 2 × 2 × 6 cm size pieces that will freely pass through the feed tube **B3**.



#### Attention:

Do not process frozen meat. Allow it to defrost before grinding it.

- Make sure that the food processor is correctly assembled and that the speed control knob **A13** is set to the OFF position.
- Place the bowl **A11** or another suitable container under the meat grinder. Insert the power plug into a power socket.
- Use the speed control knob to set the desired speed. We recommend to initially set speed 3 and then increase it as required. Gradually place the meat pieces into the feed tube **B3** and push them in using the pusher **B1**. Take care not to clog up the feed tube **B3** by a large amount of meat. Do not process more than 5 kg of meat per batch. The processing time is only several minutes.



#### Attention:

Do not use fingers or other items to push the meat in. Always use the pusher **B1** designed for this purpose.

- The ground meat will fall into the prepared bowl. The meat that remains in the grinding chamber **B4** can be removed by grinding a slice of bread or a bread roll.
- To turn off the food processor, set the speed control knob **A13** to the OFF position.
- Clean out the meat grinder after each use according to the instructions in chapter Cleaning and maintenance.

#### ASSEMBLING AND DISASSEMBLING THE SAUSAGE STUFFER ATTACHMENT

- Proceed in the same way as when assembling the meat grinder, only with the difference that instead of the grinding blade **B6** and the grinding plate **B8**, **B9** or **B10**, only parts **B11** a **B12** are used.
- Place the separator **B11** on to the screw shaft so that the notch in the grinding chamber **B4** fits into the groove in the separator **B11**. Place the sausage stuffer attachment **B12** on to the separator **B11** and complete the entire sausage stuffer assembly by screwing the screw ring **B7** on to the grinding chamber **B4**. Place the stainless steel hopper **B2** on to the feed tube **B3**.
- Attach the attachment to the food processor in the same way as described in point 4 in chapter Assembling and disassembling the meat grinder.
- When disassembling, first remove the hopper **B2**. Then press the button **A1** and remove the attachment by turning it clockwise. After removing the attachment, put the cover **A2** back in its place.
- When disassembling the attachment into its individual parts, proceed in the reverse sequence.

## USING THE SAUSAGE STUFFER ATTACHMENT

1. Make sure that the food processor is correctly assembled and that the speed control knob **A13** is set to the OFF position. Insert the power plug into a power socket.
2. Prepare a sausage casing that you will stuff with ground meat and allow it to soak in lukewarm water for approx. 10 minutes. Place the ground meat mixture on to the hopper **B2**. Take the sausage casing out of the water and skewer or tie up one end and slide the other end like a sock on to the sausage stuffer attachment **B12**.
3. Use the speed control knob **A13** to set the desired speed. We recommend to initially set the lowest speed and then increase it as required. With one hand hold the sausage casing on the attachment **B12** and use the other hand to push the ground meat mixture with the pusher **B1** through the feed tube **B3**. If the sausage casing sticks to the attachment **B12**, it is necessary to moisten it with water again.



### Attention:

Do not use fingers or other items to push the ground meat in. Always use the pusher **B1** designed for this purpose.

4. To turn off the appliance, set the speed control knob **A13** to the OFF position.
5. Clean out the individual parts of the attachment after each use according to the instructions in chapter Cleaning and maintenance.

## ASSEMBLING AND DISASSEMBLING THE KEBAB MAKER ATTACHMENT

1. Proceed in the same way as when assembling the meat grinder, only with the difference that instead of the grinding blade **B6** and the grinding plate **B8, B9** or **B10**, only parts **B13** and **B14** are used.
2. Place the moulder **B13** on to the screw shaft **B5** so that the notch in the grinding chamber **B4** fits into the groove in the moulder **B13**. Place the kebab moulder attachment **B13** on to the conical attachment **B14** and complete the entire kebab maker assembly by screwing the screw ring **B7** on to the grinding chamber **B4**. Place the stainless steel hopper **B2** on to the feed tube **B3**.
3. Attach the attachment to the food processor in the same way as described in point 4 in chapter Assembling and disassembling the meat grinder.
4. When disassembling, first remove the hopper **B2**. Then press the button **A1** and remove the attachment by turning it clockwise. After removing the attachment, put the cover **A2** back in its place.
5. When disassembling the attachment into its individual parts, proceed in the reverse sequence.

## USING THE KEBAB MAKER ATTACHMENT

1. Make sure that the food processor is correctly assembled and that the speed control knob **A13** is set to the OFF position. Insert the power plug into a power socket.
2. Place the prepared kebab meat mixture on to the hopper **B2**. Use the speed control knob **A13** to set the desired speed. We recommend to initially set the lowest speed and then increase it as required. Using the pusher **B1**, push the mixture through the feed tube **B3**. The result will be a hollow meat tube that is then cut into smaller pieces. The kebab is a traditional meal from the Middle East made predominantly from ground meat and whole grain wheat.



### Attention:

Do not use fingers or other items to push the ground meat in. Always use the pusher **B1** designed for this purpose.

3. To turn off the appliance, set the speed control knob **A13** to the OFF position.
4. Clean out the individual parts of the attachment after each use according to the instructions in chapter Cleaning and maintenance.

## ASSEMBLING AND DISASSEMBLING THE COOKIE MAKER ATTACHMENT

1. Proceed in the same way as when assembling the meat grinder, only with the difference that instead of the grinding blade **B6** and the grinding plate **B8, B9** or **B10** only parts **B11, B15** and **B16** are used.
2. Place the separator **B11** on to the screw shaft so that the notch in the grinding chamber **B4** fits into the groove in the separator **B11**. Insert the cookie maker holder **B16** into the screw ring **B7**. Screw the screw ring **B7** clockwise on to the grinding chamber **B4**. Complete the assembly by inserting the cookie maker **B15** into the holder **B16** and attaching the hopper **B2** to the feed tube **B3**.
3. Attach the attachment to the food processor in the same way as described in point 4 in chapter Assembling and disassembling the meat grinder.
4. When disassembling, first remove the hopper **B2**. Then press the button **A1** and remove the attachment by turning it clockwise. After removing the attachment, put the cover **A2** back in its place.
5. When disassembling the attachment into its individual parts, proceed in the reverse sequence.

## USING THE COOKIE MAKER ATTACHMENT

1. Place the prepared dough on to the hopper **B2**. Slide the cookie maker **B15** to the left or right to set the desired cookie shape.
2. Insert the power plug into a power socket. Set the required speed using the speed control knob **A13**. When starting it for the first time, we recommend that you set speed 3 and then increase or decrease it as required.
3. Use the pusher **B1** to push the dough through the feed tube **B3**. The food processor will push the dough out in the required shape that you set using the cookie maker **B15**. We recommend that you place a tray or your palm underneath the pushed out dough. Then cut the formed dough into smaller pieces.



### Attention:

Do not use fingers or other items to push the dough in. Always use the pusher **B1**.

4. When you have finished using the food processor, turn it off by setting the speed control knob **A13** to the OFF position.
5. Clean out the attachment after each use according to the instructions in chapter Cleaning and maintenance.

## BLENDING

### ASSEMBLING AND DISASSEMBLING THE BLENDER

1. On to the blending jar **C4**, place the outer lid **C2** so that its edges copy the neck of the jar, and push it down thoroughly along its entire perimeter. Into the hole in the lid **C2**, place the inner cap **C1** and push it down all the way.
2. Make sure that the food processor is turned off and disconnected from the power socket. The multi-function head **A8** must be tilted down in the horizontal position and the whisk, beater or kneading attachments must be removed. Release and remove the top attachment hub cover **A7**. Place the assembled blending jar on to the top hub and pulling it gently turn it in the direction of the symbol  all the way. The safety mechanism will prevent the blender from starting unless it is correctly secured to the multi-function head **A8**.
3. To disassemble proceed in the reverse sequence.
4. Prior to starting the appliance, check that the blade assembly **C6** is correctly seated in the cuff **C5**. Properly tighten the cuff **C5** on to the mixing container **C4**.

### USING THE BLENDER

1. The blender is intended for preparing meals and drinks such as milkshakes, creamy soups, sauces, spreads, fresh baby foods, etc. It is not intended for juicing fruit and vegetables, preparing potato purée, yeast dough or for whipping egg whites.
2. Assemble the blender according to the instructions in chapter Assembling and disassembling the blender, and put the ingredients (larger pieces need to be cut up in advance) into the blending jar **C4**.



### Note:

The maximum capacity of the blending jar **C4** is 1.5 litres. Never fill it past the maximum mark. When processing hot liquids or liquids that expand in volume during the blending process, it is recommended to fill the blending jar no more than 2/3 of its maximum capacity.

3. Make sure that the food processor is correctly assembled and that the speed control knob **A13** is set to the OFF position. Connect the power cord to a power socket. Set the required speed using the speed control knob **A13**. We recommend to first set a slower speed to allow the ingredients to mix together. Then the speed may be increased. The pulse level is appropriate when you wish to blend food only very quickly. To start the pulse level, turn the speed control knob **A13** to the PULSE position and hold it in this position for a moment. As soon as you release the speed control knob **A13**, it will automatically return to the OFF position.



### Attention:

Hot liquids up to a temperature of 55 °C may be processed in the blending jar. The maximum operating time of the blender is 2 minutes. Do not leave the appliance in continuous operation for longer than indicated above. Then allow it to cool down for 30 minutes.

4. While blending, you may add food or liquids to the blending jar **C4** through the hole in the lid **C2** after removing the inner cap **C1**. Never open the outer lid **C2** during operation. When processing hot liquids, the inner cap **C1** must remain closed.
5. In the event that food is sticking to the blade assembly **C6** or the walls of the blending jar **C4**, turn the appliance off by turning the speed control knob **A13** to the OFF position and disconnect it from the power socket. Make sure that the blade assembly **C6** has stopped rotating. Carefully remove the assembled blending jar from the multi-function head **A8** by turning it in the direction of the symbol . Take off the lid and using a plastic spatula, clean the blade assembly **C6** and the inside of the blending jar **C4**. Put the lid back on and reattach the blender assembly to the multi-function head **A8**. Plug the power cord into a power socket and continue blending.
6. After you have finished using the appliance, set the speed control knob **A13** to the OFF position and disconnect the power cord from the power socket. Check that the blade assembly **C6** has stopped rotating and carefully take the blending jar assembly off the multi-function head **A8**. Put the cover **A7** back in its place and use a soft plastic spatula to remove food from the blending jar **C4**.

7. Disassemble the assembled bowl and clean the individual parts after each use according to the instructions in chapter Cleaning and maintenance.

#### ADVICE AND TIPS FOR BLENDING

- First cut food with a firm consistency such as fruit and vegetables into smaller pieces measuring 3 cm and only then blend it.
- First, blend a smaller amount of ingredients and then gradually add more ingredients through the hole in the lid **C2** while blending. In this way, you will achieve better results than by adding all ingredients into the blending jar **C4** at once.
- If you need to blend food of a solid consistency together with liquids, we recommend that you first blend the food of solid consistency and a part of the liquids. Then gradually add the remaining liquids through the hole in the lid **C2** while blending.
- To blend very thick liquids, we recommend using the pulse level so that the blade assembly **C6** does not get jammed too often. Start the blender repeatedly in short intervals.
- Ice cubes must be processed immediately upon being removed from the freezer. When the ice starts to melt, the ice cubes will stick together and it will not be possible to blend them.

#### QUICK GUIDE TO PROCESSING INGREDIENTS

Ingredients	Speed selection	Recommended blending time
Fruit, vegetables cut into smaller pieces	5–6	30 s
Baby food	5–6	40 s
Spreads, dressings, marinades	3–4	30 s
Smoothies and cocktails	6 to MAX	40 s
Soups	6 to MAX	30 s
Ice cubes	PULSE	



#### Note:

The above food processing times are only a reference. The actual blending time depends on the size of the ingredients, their amount and the required final consistency.

#### CLEANING AND MAINTENANCE

- Before cleaning the food processor, always switch it off by setting the speed control knob **A13** to the OFF position and disconnect it from the power socket.
- Disassemble the food processor into its individual parts. Wait until moving parts come to a complete stop before disassembly.
- Thoroughly wash the used removable parts after every use using warm water with a neutral dishwashing detergent. Then rinse them under clean running water and wipe them dry with a fine wiping cloth or allow them to dry naturally. After washing and drying, we recommend to coat the grinding blade **B6** and the grinding plates **B8**, **B9** and **B10** with cooking oil.
- If you whisked egg whites, first rinse the bowl **A11** and the beater **A4** or **A6** under cold water. If you were to use hot water, the egg white remains would harden and their removal would be more difficult.
- Clean the mixing container **C4** by filling it with 0.5 litre of clean water and a few drops of kitchen detergent and then assemble the blender and run it for 10 to 15 seconds. Then turn off the food processor, disconnect it from the power socket, and after the rotating parts have come to a stop, remove the blending jar assembly. Empty out the contents of the blending jar **C4** and then thoroughly rinse out the blending jar **C4** with clean water and wipe dry.
- If more thorough cleaning is required, the cuff **C5** with blade assembly **C6** may be removed using a special wrench that can be ordered free of charge at an authorised service centre. After cleaning, it is necessary to install the cuff **C5** with blade assembly **C6** back in its place and to properly tighten it using the wrench.

#### Attention:

When cleaning, be very careful not to injure yourself on the sharp cutting edge.



- The metal parts of the meat grinder, the blade assembly **C6** and attachments **A3–A6** are not intended for washing in a dishwasher. Other removable parts may be washed in a dishwasher.
- For cleaning the base unit **A12** and the multi-function head **A8**, use a cloth lightly dipped in a weak detergent solution. Then wipe everything with a clean dampened cloth and thoroughly wipe dry.
- For cleaning, do not use solvents or cleaning agents with abrasive effects. Otherwise, the surface of the appliance may be damaged.
- Do not submerge the food processor or its power cord in water or any other liquids.

#### STORAGE

- When not using the food processor, store it in a clean, dry place out of children's reach. Make sure that the multi-function head **A8** is tilted down into the horizontal position.

#### TECHNICAL SPECIFICATIONS

Rated voltage range.....	220–240 V
Rated frequency.....	50/60 Hz
Rated power input.....	1 000 W
Electrical shock protection class.....	II
Noise level.....	85 dB(A)

The declared noise emission level of the appliance is 85 dB(A), which represents a level A of acoustic power with respect to a reference acoustic power of 1 pW.

#### Explanation of technical terminology

Safety class for electrical shock protection:

Class II – Electrical shock protection is provided by double or heavy-duty insulation.

#### INSTRUCTIONS AND INFORMATION REGARDING THE DISPOSAL OF USED PACKAGING MATERIALS

Dispose of used packaging material at a site designated for waste in your municipality.

#### DISPOSAL OF USED ELECTRICAL AND ELECTRONIC EQUIPMENT



This symbol on products or original documents means that used electric or electronic products must not be added to ordinary municipal waste. For proper disposal, renewal and recycling hand over these appliances to determined collection points. Alternatively, in some European Union states or other European countries you may return your appliances to the local retailer when buying an equivalent new appliance.



Correct disposal of this product helps save valuable natural resources and prevents potential negative effects on the environment and human health, which could result from improper waste disposal. Ask your local authorities or collection facility for more details.

In accordance with national regulations penalties may be imposed for the incorrect disposal of this type of waste.

#### For business entities in European Union states

If you want to dispose of electric or electronic appliances, ask your retailer or supplier for the necessary information.

#### Disposal in other countries outside the European Union

This symbol is valid in the European Union. If you wish to dispose of this product, request the necessary information about the correct disposal method from the local council or from your retailer.



This product meets all the basic requirements of EU directives related to it.