

USER MANUAL

ProLite

LCD Monitor

ENGLISH

ProLite B2791HSU
ProLite E2791HSU

Thank you very much for choosing the iiyama LCD monitor.

We recommend that you take a few minutes to read this comprehensive manual carefully before installing and switching on the monitor. Please keep this manual in a safe place for your future reference.



Dear user, we congratulate you on the purchase of your iiyama LCD.

For details on warranty and locally used pixel policies that apply directly after installation of your product please check the iiyama website.

To report a fault, please contact your local support centre found at www.iiyama.com/service

Things to check before you call the iiyama information line

- | if the power cable is connected securely and turned on?
- | if the display has been turned on?
- | if the signal cable is connected securely and the correct input selected?
- | if the computer has been restarted with the display connected?
- | if the graphics card is correctly installed with the latest drivers possible?
- | if the correct native resolution has been selected via 'Display Properties'?
- | If the R/G/B signal configuration is correct?
- | if the displays On Screen Menu is shown?
- | if the correct brightness and contrast settings have been set?
- | if given display tolerances and compatibility have been considered?
- | if via the On Screen Menu you have performed a Factory Reset/Recall?

Before reporting the screen defect, please prepare the following information/evidence:

- | model number *
- | purchase receipt and serial number *
- | name and address for collection
- | telephone/fax number, for availability during the day
- | convenient collection date (date, time)
- | short description of the defect

Important Note:

If there is no fault found in the collected equipment after inspection, the transferring party shall incur charges for transport and administration.

If you have checked all of the above and there is still no picture, call our information line for assistance in your country.

* see the identification plate on the back of the case.

CE MARKING DECLARATION OF CONFORMITY

This LCD monitor complies with the requirements of the EC/EU Directive 2014/30/EU "EMC Directive", 2014/35/EU "Low Voltage Directive", 2009/125/EC "ErP Directive" and 2011/65/EU "RoHS Directive".

The electro-magnetic susceptibility has been chosen at a level that gives correct operation in residential areas, business and light industrial premises and small-scale enterprises, inside as well as outside of the buildings. All places of operation are characterised by their connection to the public low voltage power supply system.

IYAMA CORPORATION: Wijkerveerstraat 8, 2131 HA Hoofddorp, The Netherlands

Model No. : PL2792H



We recommend recycling of used product. Please contact your dealer or iiyama service center. Recycle information is obtained via the Internet, using the address: <http://www.iiyama.com>

You can access the Web page of different countries from there.

- We reserve the right to change specifications without notice.
- All trademarks used in this user manual are the property of their respective owners.
- As an ENERGY STAR® Partner, iiyama has determined that this product meets the ENERGY STAR® guidelines for energy efficiency.
- This product qualifies for ENERGY STAR® in the "factory default" setting and this is the setting in which power saving will be achieved. Changing the factory default picture settings or enabling other features will increase power consumption that could exceed the limits necessary to qualify for ENERGY STAR® rating.
- The terms HDMI and HDMI High-Definition Multimedia Interface, and the HDMI Logo are trademarks or registered trademarks of HDMI Licensing Administrator, Inc. in the United States and other countries.
- Eprel registration number B2791HSU-B1 C : 361952, E2791HSU-B1 : 405448

TABLE OF CONTENTS

| | |
|---|----|
| FOR YOUR SAFETY..... | 1 |
| SAFETY PRECAUTIONS..... | 1 |
| SPECIAL NOTES ON LCD MONITORS..... | 3 |
| CUSTOMER SERVICE..... | 3 |
| CLEANING..... | 3 |
| BEFORE YOU OPERATE THE MONITOR..... | 4 |
| FEATURES..... | 4 |
| CHECKING THE CONTENTS OF THE PACKAGE..... | 4 |
| INSTALLATION..... | 5 |
| FITTING AND REMOVAL OF BASE : ProLite B2791HSU..... | 7 |
| FITTING AND REMOVAL OF BASE : ProLite E2791HSU..... | 9 |
| CONTROLS AND CONNECTORS : ProLite B2791HSU..... | 10 |
| CONTROLS AND CONNECTORS : ProLite E2791HSU..... | 11 |
| CONNECTING YOUR MONITOR : ProLite B2791HSU..... | 12 |
| CONNECTING YOUR MONITOR : ProLite E2791HSU..... | 13 |
| DISCONNECTING YOUR MONITOR..... | 14 |
| COMPUTER SETTING..... | 15 |
| ADJUSTING THE VIEWING ANGLE : ProLite E2791HSU..... | 15 |
| ADJUSTING THE HEIGHT AND THE VIEWING ANGLE : | |
| ProLite B2791HSU..... | 16 |
| OPERATING THE MONITOR..... | 17 |
| ADJUSTMENT MENU CONTENTS..... | 18 |
| SCREEN ADJUSTMENTS..... | 28 |
| STANDBY FEATURE..... | 31 |
| TROUBLE SHOOTING..... | 32 |
| RECYCLING INFORMATION..... | 33 |
| APPENDIX..... | 34 |
| SPECIFICATIONS : ProLite B2791HSU..... | 34 |
| SPECIFICATIONS : ProLite E2791HSU..... | 35 |
| DIMENSIONS : ProLite B2791HSU..... | 36 |
| DIMENSIONS : ProLite E2791HSU..... | 36 |
| COMPLIANT TIMING..... | 37 |

FOR YOUR SAFETY

SAFETY PRECAUTIONS

WARNING

STOP OPERATING THE MONITOR WHEN YOU SENSE TROUBLE

If you notice any abnormal phenomena such as smoke, strange sounds or fumes, unplug the monitor and contact your dealer or iiyama service center immediately. Further use may be dangerous and can cause fire or electric shock.

NEVER REMOVE THE CABINET

High voltage circuits are inside the monitor. Removing the cabinet may expose you to the danger of fire or electric shock.

DO NOT PUT ANY OBJECT INTO THE MONITOR

Do not put any solid objects or liquids such as water into the monitor. In case of an accident, unplug your monitor immediately and contact your dealer or iiyama service center. Using the monitor with any object inside may cause fire, electric shock or damage.

INSTALL THE MONITOR ON A FLAT, STABLE SURFACE

The monitor may cause an injury if it falls or is dropped.

DO NOT USE THE MONITOR NEAR WATER

Do not use where water may be splashed or spilt onto the monitor as it may cause fire or electric shock.

OPERATE UNDER THE SPECIFIED POWER SUPPLY

Be sure to operate the monitor only with the specified power supply. Use of an incorrect voltage will cause malfunction and may cause fire or electric shock.

PROTECT THE CABLES

Do not pull or bend the power cable and signal cable. Do not place the monitor or any other heavy objects on the cables. If damaged, the cables may cause fire or electric shock.

ADVERSE WEATHER CONDITIONS

It is advisable not to operate the monitor during a heavy thunder storm as the continual breaks in power may cause malfunction. It is also advised not to touch the plug in these circumstances as it may cause electric shock.

CAUTION

INSTALLATION LOCATION

Do not install the monitor where sudden temperature changes may occur, or in humid, dusty or smoky areas as it may cause fire, electric shock or damage. You should also avoid areas where the sun shines directly on the monitor.

DO NOT PLACE THE MONITOR IN A HAZARDOUS POSITION

The monitor may topple and cause injury if not suitably located. Please also ensure that you do not place any heavy objects on the monitor, and that all cables are routed such that children may not pull the cables and possibly cause injury.

MAINTAIN GOOD VENTILATION

Ventilation slots are provided to keep the monitor from overheating. Covering the slots may cause fire. To allow adequate air circulation, place the monitor at least 10cm (or 4 inches) from any walls. When removing the tilt stand, the ventilation slots on the back side of the monitor can be blocked. This may overheat the monitor and may cause fire or damage. Make sure to allow enough ventilation when removing the tilt stand. Operating the monitor on its back, side, upside down or on a carpet or any other soft material may also cause damage.

DISCONNECT THE CABLES WHEN YOU MOVE THE MONITOR

When you move the monitor, turn off the power switch, unplug the monitor and be sure the signal cable is disconnected. If you do not disconnect them, it may cause fire or electric shock.

UNPLUG THE MONITOR

If the monitor is not in use for a long period of time it is recommended that it is left unplugged to avoid accidents.

HOLD THE PLUG WHEN DISCONNECTING

To disconnect the power cable or signal cable, always pull it by the plug. Never pull on the cable itself as this may cause fire or electric shock.

DO NOT TOUCH THE PLUG WITH WET HANDS

Pulling or inserting the plug with wet hands may cause electric shock.

WHEN YOU INSTALL THE MONITOR ON YOUR COMPUTER

Be sure the computer is strong enough to hold the weight of the monitor, otherwise, you may damage your computer.

CAREFUL! PROTECT YOUR HANDS AND FINGERS

- Be careful not to hurt your fingers or hands when you change the height or the angle.
- Injury can occur if care is not taken to avoid finger contact with the displays base when adjusting the height. (Just for height adjustable model.)

REMARK FOR 24/7 USAGE

This product is not specifically designed for 24/7 usage in all environments.

REMARK FOR WALL MOUNTING

This product is not designed for digital signage (electronic signboard) applications such as wall mounting.

OTHERS

ERGONOMIC RECOMMENDATIONS

To eliminate eye fatigue, do not operate the monitor against a bright background or in a dark room. For optimal viewing comfort, the monitor should be just below eye level and 40-60 cm (16-24 inches) away from your eyes. When using the monitor over a prolonged time, a ten minute break every hour is recommended as looking at the screen continuously can cause eye strain.

SPECIAL NOTES ON LCD MONITORS

The following symptoms are normal with LCD monitors and do not indicate a problem.

NOTE

- When you first turn on the LCD monitor, the picture may not fit in the display area because of the type of computer that is used. In this case, adjust the picture position to the correct position.
- You may find slightly uneven brightness on the screen depending on the desktop pattern you use.
- Due to the nature of the LCD screen, an afterimage of the previous screen may remain after switching the image, when the same image is displayed for hours. In this case, the screen can be recovered slowly by changing the image or turning off the Power Switch for some hours.

CUSTOMER SERVICE

NOTE

- If you have to return your unit for service and the original packaging has been discarded, please contact your dealer or iiyama service center for advice or replacement packaging.

CLEANING

WARNING

- If you drop any materials or liquids such as water into the monitor when cleaning, unplug the power cable immediately and contact your dealer or iiyama service center.

CAUTION

- For safety reasons, turn off the power switch and unplug the monitor before you clean it.

NOTE

- To protect the LCD panel, do not scratch or rub the screen with a hard object.
- Never use any of the following strong solvents. These will damage the cabinet and the LCD screen.

| | |
|------------------|--------------------------|
| Thinner | Spray-type cleaner |
| Benzine | Wax |
| Abrasive cleaner | Acid or Alkaline solvent |

- Touching the cabinet with any product made from rubber or plastic for a long time may cause degeneration or loss of paint on the cabinet.

CABINET

Stains can be removed with a cloth lightly moistened with a mild detergent solvent. Then wipe the cabinet with a soft dry cloth.

LCD SCREEN

Periodic cleaning with a soft dry cloth is recommended.

Don't use tissue paper etc. because these will damage the LCD screen.

BEFORE YOU OPERATE THE MONITOR

FEATURES

- ◆ Supports Resolutions up to 1920 × 1080
- ◆ High Contrast 1000:1 (Typical), Adv. Contrast Function Available / Brightness 300cd/m² (Typical)
- ◆ Quick Response Time 1ms (Gray to Gray)
- ◆ Supports AMD Radeon FreeSync™ technology (through HDMI/DisplayPort-inputs)
- ◆ Flicker - Free
- ◆ Blue Light Reducer
- ◆ Digital Character Smoothing
- ◆ Automatic Set-up
- ◆ 2 × 2W Stereo Speakers
- ◆ Standby Feature (ENERGY STAR® and VESA DPMS Compliant)
- ◆ VESA Mounting Standard (100mm×100mm) Compliant
- ◆ Keyhole for Security Lock

CHECKING THE CONTENTS OF THE PACKAGE

The following accessories are included in your package. Check to see if they are enclosed with the monitor. If anything is missing or damaged, please contact your local iiyama dealer or regional iiyama office.

- | | | |
|-----------------------------|-----------------------|------------------------------|
| ■ Power Cable* ¹ | ■ HDMI Cable | ■ USB Cable |
| ■ Stand-Base with a screw | ■ Stand* ² | ■ Cable Holder* ² |
| ■ Safety Guide | ■ Quick Start Guide | |

CAUTION

*¹ The rating of the Power Cable enclosed in 120V area is 10A/125V. If you are using a power supply higher than this rating, then a power cable with a rating of 10A/250V must be used. However, all guarantees and warranties are void for any problems or damage caused by a power cable not supplied by iiyama.

An approved power cable greater or equal to H05VVVF, 3G, 0.75mm² must be used.

*² Accessory for ProLite E2791HSU.

INSTALLATION

WARNING

- Before installation, make sure the display arm or desk arm stand is strong enough to hold the necessary weight of the display and the mount.
- Angle adjustment range :
22 degrees upward and 5 degrees downward

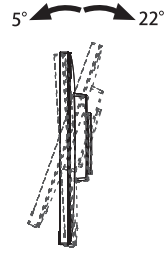

< DISPLAY ARM OR DESK ARM STAND >

WARNING

When you use with the display arm or desk arm stand, in consideration of thickness of the mounting stage, tighten the M4 Screws (4pcs) with washer which "L" length is 7mm to fasten the monitor. Using the screw longer than this may cause electric shock or damage because it may contact with the electrical parts inside the monitor.

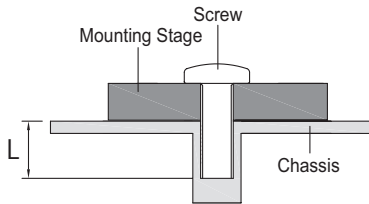

< ROTATING THE DISPLAY >

● ProLite B2791HSU

The monitor is designed to be compatible with both landscape and portrait modes. Video card for portrait display will be required for rotating the image on the screen.

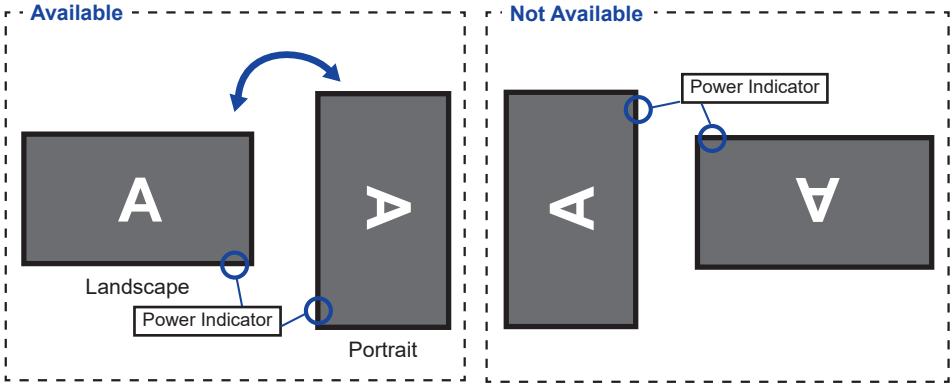

With Stand:

NOTE

- Adjust the monitor's height before panel rotation.
- Attempting to rotate the panel forcibly without adjusting the stand height may cause damage to the panel or the stand.

● ProLite E2791HSU

It is designed to be compatible in landscape mode.

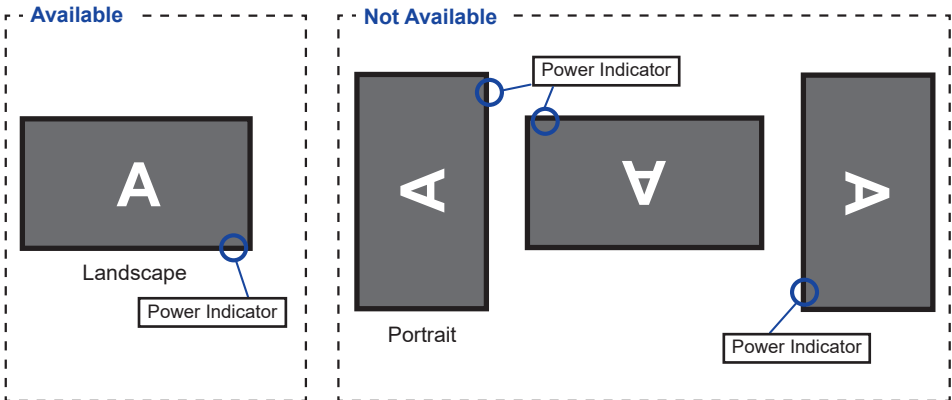

FITTING AND REMOVAL OF BASE : ProLite B2791HSU

CAUTION

- Put the monitor on a stable surface. The monitor may cause injury or damage if it falls or is dropped.
- Do not give a strong impact to the monitor. It may cause damage.
- Unplug the monitor before removal or installation to avoid an electric shock or a damage.

<Installation>

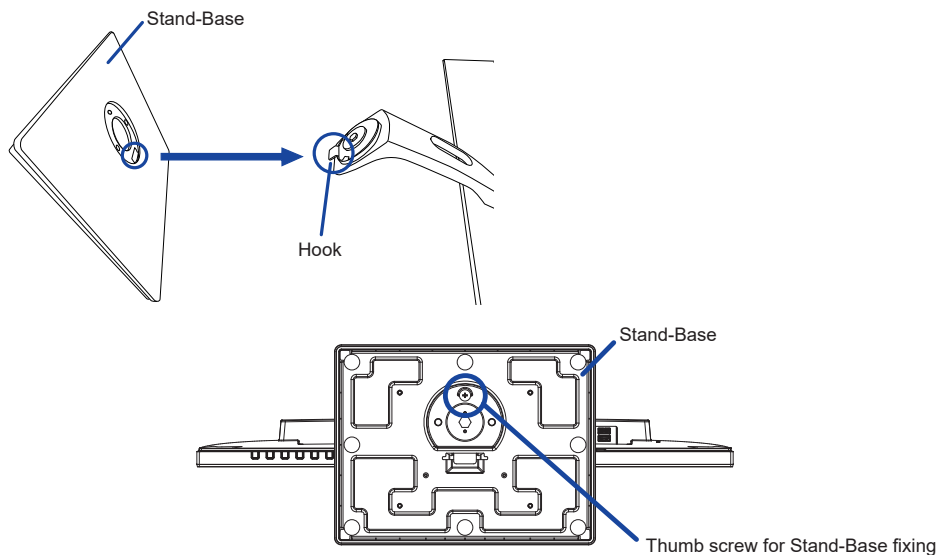

- ① Put a piece of soft cloth on the table beforehand to prevent the monitor from being scratched. Lay the monitor flat on a table with front face down.
- ② Install the stand-base as shown on above picture.
- ③ Use the 'thumb screw' provided to secure the base to the monitor.

<Removal>

- ① Put a piece of soft cloth on the table beforehand to prevent the monitor from being scratched. Lay the monitor flat on a table with front face down.
- ② Loosen the 'thumb screw' to remove the Stand-Base from the monitor.

<Removing the stopper>*

Place the monitor upright on a flat, stable surface.

1. Remove the tape.
2. Push down the monitor head.
3. Remove the stopper.

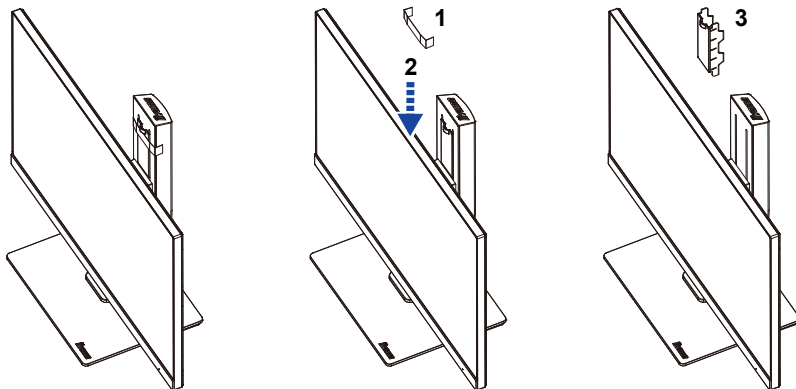

* with stopper models

FITTING AND REMOVAL OF BASE : ProLite E2791HSU

CAUTION

- Put the monitor on a stable surface. The monitor may cause injury or damage if it falls or is dropped.
- Do not give a strong impact to the monitor. It may cause damage.
- Unplug the monitor before removal or installation to avoid an electric shock or a damage.

<Installation>

- ① Put a piece of soft cloth on the table beforehand to prevent the monitor from being scratched. Lay the monitor flat on a table with front face down.
- ② Hold the monitor and install the stand. Secure it using the screw provided.
- ③ Install the stand-base to the stand.
- ④ Use the 'thumb screw' provided to secure the base to the monitor.
- ⑤ Place the Cable Holder.

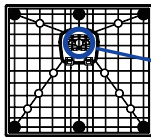

Thumb screw
for Stand-Base fixing

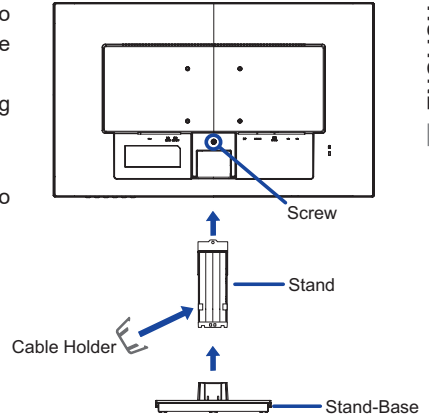

<Removal>

- ① Put a piece of soft cloth on the table beforehand to prevent the monitor from being scratched. Lay the monitor flat on a table with front face down.
- ② Remove the 'thumb screw' to remove the base from the monitor.
- ③ Unfix the screw and remove the Stand.
- ④ Pull the hook of the Cable Holder outside and remove it.

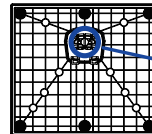

Thumb screw
for Stand-Base fixing

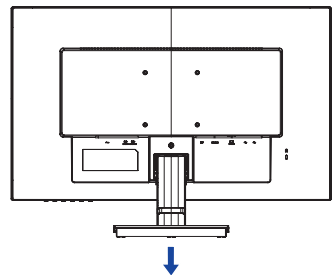
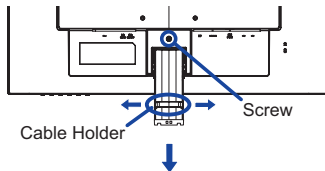

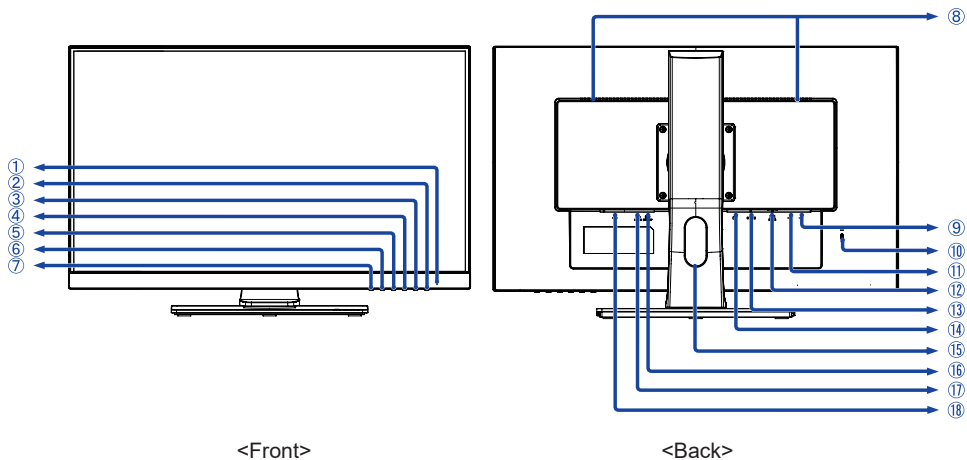

① Power Indicator

NOTE Blue: Normal operation
Orange: Standby mode

② Power Switch (⏻)

③ Menu / Select Button (ENTER)

④ Scroll Up / Volume Button (▶ / 🔊)

⑤ Scroll Down / ECO Mode Button (◀ / ⓪)

⑥ Exit Button (EXIT)

⑦ Input Select Button (INPUT)

⑧ Speakers

⑨ USB Downstream Connector (🔌, 5V, 500mA)

⑩ Keyhole for Security Lock

NOTE You can fasten a security lock and cable to prevent the monitor from being removed without your permission.

⑪ USB Upstream Connector (🔌)

⑫ VGA Connector (D-SUB)

⑬ HDMI Connector (HDMI)

⑭ DisplayPort Connector (DP)

⑮ Cable Hole

⑯ Headphone Connector (LINE OUT)

⑰ Audio Connector (LINE IN)

⑱ AC Connector (~ : Alternating current) (~)

CONTROLS AND CONNECTORS : ProLite E2791HSU

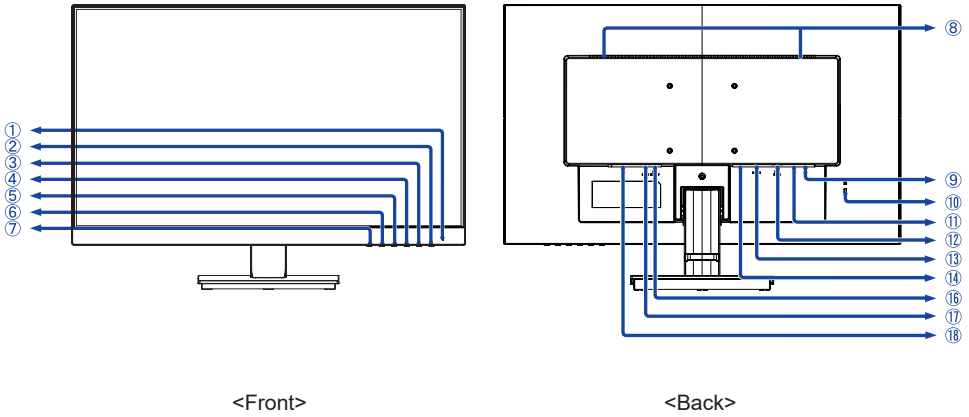

ENGLISH

- ① Power Indicator

NOTE Blue: Normal operation
Orange: Standby mode

- ② Power Switch (⏻)
- ③ Menu / Select Button (ENTER)
- ④ Scroll Up / Volume Button (▶ / 🔊)
- ⑤ Scroll Down / ECO Mode Button (◀ / ⓪)
- ⑥ Exit Button (EXIT)
- ⑦ Input Select Button (INPUT)
- ⑧ Speakers
- ⑨ USB Downstream Connector (⏏, 5V, 500mA)
- ⑩ Keyhole for Security Lock
- NOTE** You can fasten a security lock and cable to prevent the monitor from being removed without your permission.
- ⑪ USB Upstream Connector (⏏)
- ⑫ VGA Connector (D-SUB)
- ⑬ HDMI Connector (HDMI)
- ⑭ DisplayPort Connector (DP)
- ⑯ Headphone Connector (LINE OUT)
- ⑰ Audio Connector (LINE IN)
- ⑱ AC Connector (⏚ : Alternating current) (⌚)

CONNECTING YOUR MONITOR : ProLite B2791HSU

- ① Ensure that both the computer and the monitor are switched off.
- ② Connect the computer to the monitor with the signal cable.
- ③ Connect the monitor to the audio equipment with the Audio Cable for computer when using the audio features.
- ④ Connect the Power Cable to the monitor first and then to the power source.
- ⑤ Turn on your monitor and computer.

NOTE

- Make sure that the building installation has a circuit breaker of 120/240V, 20A (maximum).
- The signal cables used for connecting the computer and monitor may vary with the type of computer used. An incorrect connection may cause serious damage to both the monitor and the computer. The cable supplied with the monitor is for a standard connector. If a special cable is required please contact your local iiyama dealer or regional iiyama office.
- Make sure you tighten the finger screws at each end of the signal cable.
- The Class I pluggable equipment Type A must be connected to protective earth.
- The socket-outlet shall be installed near the equipment and shall be easily accessible.
- Excessive sound pressure from ear-/headphones can cause hearing damage/hearing loss.

[Example of Connection]

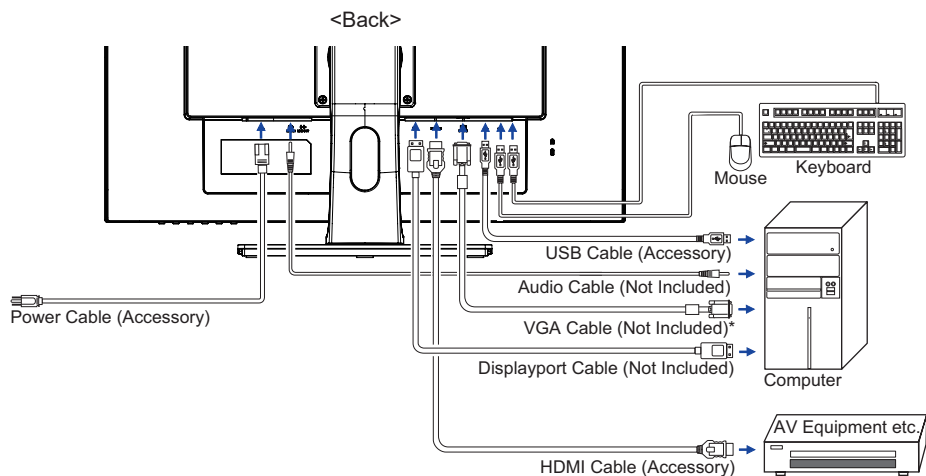

* VGA cable is not supplied with the monitor. If you use low quality VGA cable, it may cause a result of electro-magnetic interference. Please contact the iiyama Support Centre in your country if you wish to connect the monitor via the VGA input.

[Collect Cables]

Put the cables through the cable hole to bundle them.

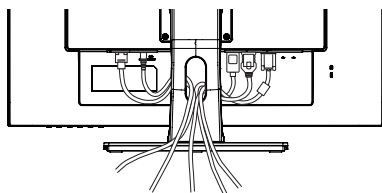

CONNECTING YOUR MONITOR : ProLite E2791HSU

- ① Ensure that both the computer and the monitor are switched off.
- ② Connect the computer to the monitor with the signal cable.
- ③ Connect the monitor to the audio equipment with the Audio Cable for computer when using the audio features.
- ④ Connect the Power Cable to the monitor first and then to the power source.
- ⑤ Turn on your monitor and computer.

NOTE

- Make sure that the building installation has a circuit breaker of 120/240V, 20A (maximum).
- The signal cables used for connecting the computer and monitor may vary with the type of computer used. An incorrect connection may cause serious damage to both the monitor and the computer. The cable supplied with the monitor is for a standard connector. If a special cable is required please contact your local iiyama dealer or regional iiyama office.
- Make sure you tighten the finger screws at each end of the signal cable.
- The Class I pluggable equipment Type A must be connected to protective earth.
- The socket-outlet shall be installed near the equipment and shall be easily accessible.
- Excessive sound pressure from ear/headphones can cause hearing damage/hearing loss.

[Example of Connection]

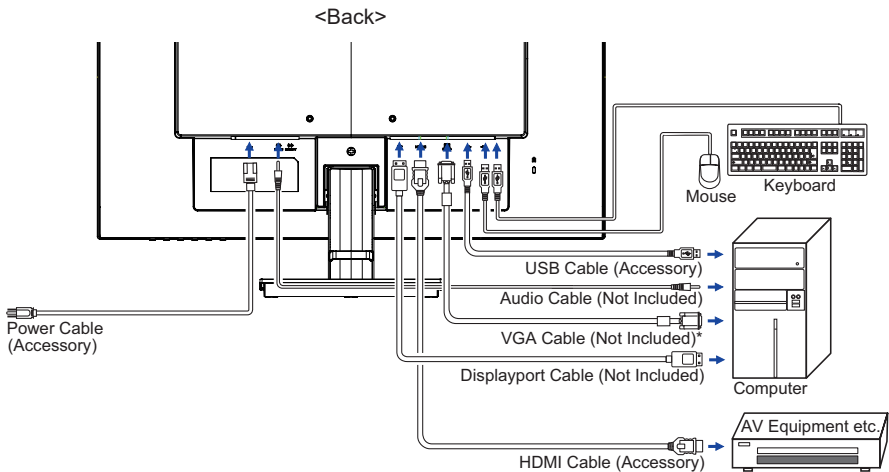

* VGA cable is not supplied with the monitor. If you use low quality VGA cable, it may cause a result of electro-magnetic interference. Please contact the iiyama Support Centre in your country if you wish to connect the monitor via the VGA input.

[Collect Cables]

Put the cables through the cable holder to bundle them.

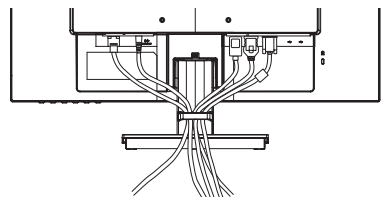

BEFORE YOU OPERATE THE MONITOR 13

DISCONNECTING YOUR MONITOR

- ① Ensure that both the computer and the monitor are switched off.
- ② Disconnect the power source first and then the Power Cable from the monitor.
- ③ Disconnect the signal cable from the computer and the monitor.
- ④ Disconnect the audio cable from the computer and the monitor.

COMPUTER SETTING

■ Signal Timing

Change to the desired signal timing listed on page 37: COMPLIANT TIMING.

ADJUSTING THE VIEWING ANGLE : ProLite E2791HSU

- For optimal viewing it is recommended to look at the full face of the monitor.
- Hold the stand so that the monitor does not topple when you change the monitor's angle.
- You are able to adjust the monitor's angle up to 22° upward, 5° downward.
- In order to ensure a healthy and relaxed body position when using the monitor at visual display workstations, it is recommended that the adjusted tilt angle should not exceed 10 degrees. Adjust the monitor's angle to your own preference.

NOTE

- Do not touch the LCD screen when you change the angle. It may cause damage or break the LCD screen.
- Careful attention is required not to pinch your fingers or hands into the moving part of the stand when you change the angle.

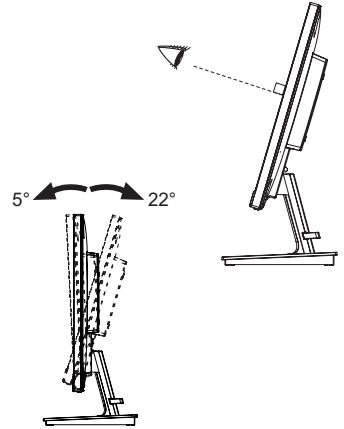

ADJUSTING THE HEIGHT AND THE VIEWING ANGLE : ProLite B2791HSU

- For optimal viewing it is recommended to position yourself directly opposite to the full face of the monitor, then adjust the monitor's height and angle to your own preference.
- Hold the panel so that the monitor does not topple when you change the monitor's height or angle.
- You are able to adjust the monitor's height up to 130mm, angle up to 45 degrees right and left, 22 degrees upward and 5 degrees downward.

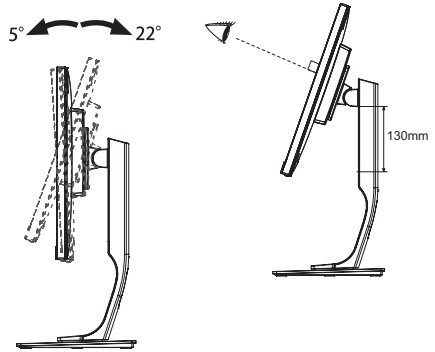

- NOTE**
- Do not touch the LCD screen when you change the height or the angle. It may cause damage or break the LCD screen.
 - Careful attention is required not to pinch your fingers or hands into the moving part of the stand when you change the height or the angle.
 - Injury can occur if care is not taken to avoid finger contact with the displays base when adjusting the height.

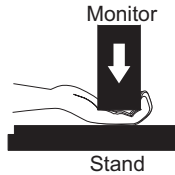

OPERATING THE MONITOR

To create the best picture, your iiyama LCD monitor has been preset at the factory with the COMPLIANT TIMING shown on page 37. You are also able to adjust the picture by following the button operation shown below. For more detailed adjustments, see page 28 for SCREEN ADJUSTMENTS.

- 1 Press the ENTER Button to start the On Screen Display feature. There are additional Menu items which can be switched by using the ◀ / ▶ Buttons.



- 2 Select the Menu item which contains the adjustment icon relating to the adjustment you want to make. Press the ENTER Button. Then, use the ◀ / ▶ Buttons to highlight the desired adjustment icon.
- 3 Press the ENTER Button again. Use the ◀ / ▶ Buttons to make the appropriate adjustment or setting.
- 4 Press the EXIT Button to leave the menu, and the settings you just made would be automatically saved.

For example, to correct for vertical position, select Menu item of Geometry and then press the ENTER Button. Then, select Vertical Position by using the ◀ / ▶ Buttons.

An adjustment page appears after you press the ENTER Button. Then, use the ◀ / ▶ Buttons to change the vertical position settings. The vertical position of the overall display should be changing accordingly while you are doing this.

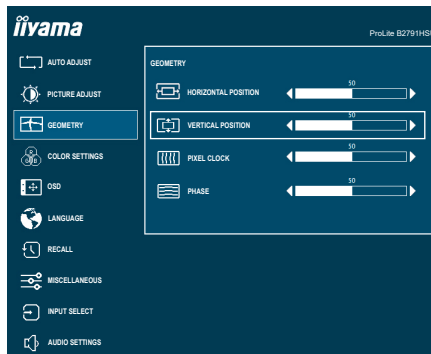

Press the EXIT Button lastly, it ends, all changes are saved in the memory.

NOTE

- When button operations are aborted during adjustment, On-Screen Display disappears when the time set for the OSD Timeout has passed. Also, press the EXIT button to quickly turn off the On-Screen Display.
- Any changes are automatically saved in the memory when the On Screen Display disappears. Turning off the power should be avoided while using the Menu.
- Adjustments for Horizontal / Vertical Position, Pixel Clock and Phase are saved for each signal timing. Except for these adjustments, all other adjustments have only one setting which applies to all signal timings.

ADJUSTMENT MENU CONTENTS

Auto Adjust

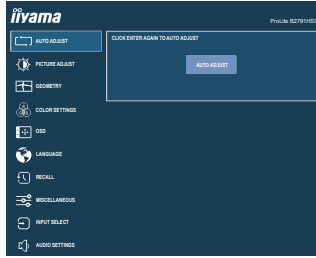

| Adjustment Item | Problem / Option | Button to Press |
|-----------------|---|-----------------|
| Auto Adjust * | Adjust H. / V. Position, Clock and Phase automatically. | |

* Only Analog Input.

For best results, use the Auto Adjust in conjunction with the adjustment pattern. See page 28 for SCREEN ADJUSTMENTS.



Picture Adjust *1

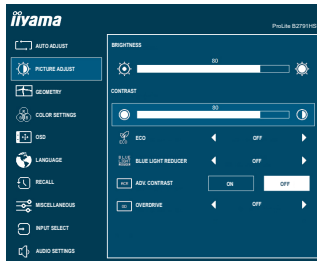

| Adjustment Item | Problem / Option | Button to Press |
|----------------------------------|--|--|
| Brightness *2,3,4 | Too dark Too bright | |
| Contrast *3 | Too dull Too intense | |
| ECO *3 Direct | Off | Normal |
| | Mode1 | Brightness of back-light is reduced. |
| | Mode2 | Brightness of back-light is reduced more than Mode1. |
| | Mode3 | Brightness of back-light is reduced more than Mode2. |
| Blue Light Reducer Direct | Off | Typical |
| | Mode1 | Blue light is reduced. |
| | Mode2 | Blue light is reduced more than Mode1. |
| | Mode3 | Blue light is reduced more than Mode2. |
| Adv. Contrast *4 | On | Increased Contrast Ratio |
| | Off | Typical Contrast Ratio |
| Overdrive | Off / 1 / 2 / 3 It will improve the gray level response time of the LCD panel. A higher level results in a faster response time. | |

*1 Picture Adjust is disabled when i-Style Color is activated.

*2 Adjust the Brightness when you are using the monitor in a dark room and feel the screen is too bright.

*3 Contrast, Brightness and ECO adjustments are disabled when Adv. Contrast is activated.

*4 Brightness and Adv. Contrast adjustment are disabled when ECO is activated.









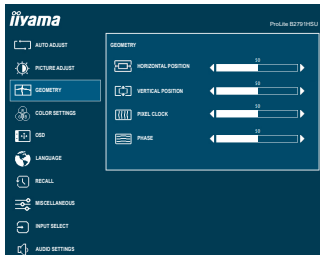











Direct

You can skip the Menu items and directly display an option setting screen by using the following button operations.

- ECO : Press the Button when the Menu is not displayed.
- Blue Light Reducer : Press and hold the EXIT Button for 2-3 seconds when the Menu is not displayed.

Geometry *





| Adjustment Item | Problem / Option | Button to Press |
|---------------------|--|--|
| Horizontal Position |  Too left |   |
| |  Too right |   |
| Vertical Position |  Too low |   |
| |  Too high |   |
| Pixel Clock |  Too narrow |   |
| |  Too wide |   |
| Phase | To correct flickering text or lines |   |

* Only Analog Input.

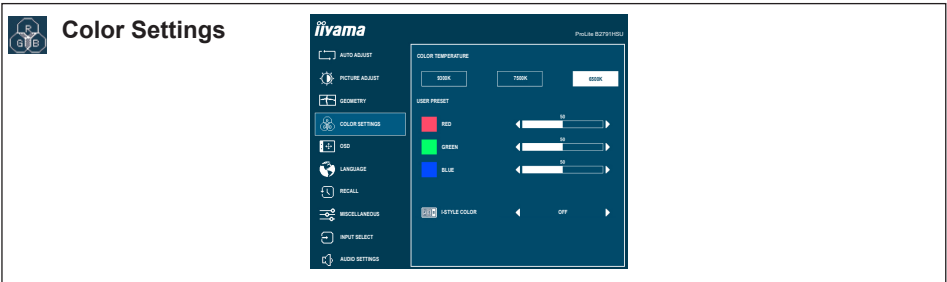
See page 28 for SCREEN ADJUSTMENTS.



| Adjustment Item | Problem / Option | Button to Press |
|--------------------------------|------------------|--|
| Color Temperature *1 | 9300K | Cool color |
| | 7500K | Normal color |
| | 6500K | Warm color |
| User Preset *1 | Red | Too weak  |
| | Green | |
| | Blue | Too strong  |
| i-Style Color *2 Direct | Off | Return to a state set by color adjustment except i-Style Color. |
| | Standard | For general windows environment and monitor default setting. |
| | Game | For PC game environment. |
| | Cinema | For movie and video environment. |
| | Scenery | For displaying outdoor scenery images |
| | Text | For text editing and viewing in a word processing environment. |

*1 Color Temperature and User Preset settings are disabled when i-Style Color or Blue Light Reducer is activated.







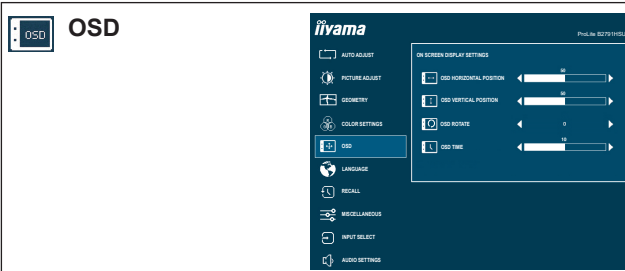

*2 i-Style Color adjustment is disabled when Blue Light Reducer is activated.

Direct

You can skip the Menu items and directly display an option setting screen by using the following button operations.

- i-Style Color : Press the EXIT Button when the Menu is not displayed.



| Adjustment Item | Problem / Option | Button to Press |
|-------------------------|---|---|
| OSD Horizontal Position | OSD is too left OSD is too right |   |
| OSD Vertical Position | OSD is too low OSD is too high |   |
| OSD Rotate * | Rotate the OSD. 0° (Normal) / +90° (Rotate right) / -90° (Rotate left) |   |
| OSD Time | You can set the OSD display duration time between 5 and 30 seconds. |   |

* Available for ProLite B2791HSU only.



Language

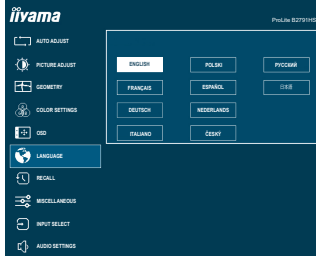

| Adjustment Item | Problem / Option | | | | Button to Press |
|-----------------|------------------|---------|------------|----------|-----------------|
| Language | English | English | Español | Spanish | |
| | Français | French | Nederlands | Dutch | |
| | Deutsch | German | Česky | Czech | |
| | Italiano | Italian | Русский | Russian | |
| | Polski | Polish | 日本語 | Japanese | |



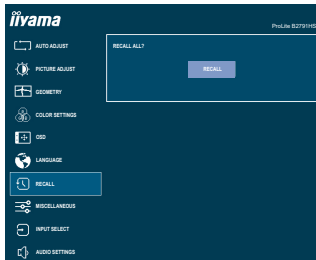

Recall

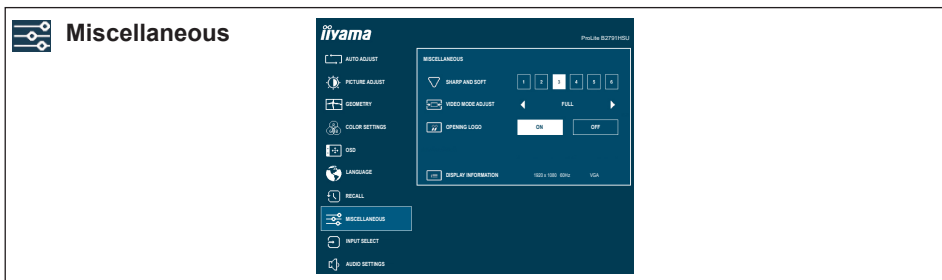

| Adjustment Item | Problem / Option | | Button to Press |
|-----------------|----------------------------------|--|-----------------|
| Recall | Factory-preset data is restored. | | |



| Adjustment Item | Problem / Option | | Button to Press |
|---------------------|---|---|---|
| Sharp and Soft | 1 2 3 4 5 6 You can change the picture quality from 1 to 6 (sharp to soft). Press the ► Button to change the picture quality in numerical order. Press the ◀ Button to change the picture quality in reverse numerical order. | |   |
| Video Mode Adjust | Full | Full screen display | |
| | Aspect * | Expansion display of Aspect | |
| Opening Logo | On | iiyama Logo is displayed when the monitor is turned on. | |
| | Off | iiyama Logo is not displayed when the monitor is turned on. | |
| Display Information | Displays information regarding the current input signal coming from the graphic card in your computer. NOTE See your graphic card user guide for more information about changing the resolution and refresh. | | |

* Option is unavailable with 16:9 resolution.



Input Select

Direct

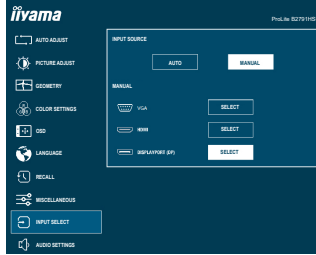

| Adjustment Item | Problem / Option | | Button to Press |
|-----------------|------------------|--|---|
| Input Source | Auto | Search for an available input source and select automatically. | |
| | Manual | VGA | Select the Analog (VGA) input. |
| | | HDMI | Select the Digital (HDMI) input. |
| | | DisplayPort | Select the Digital (DisplayPort) input. |





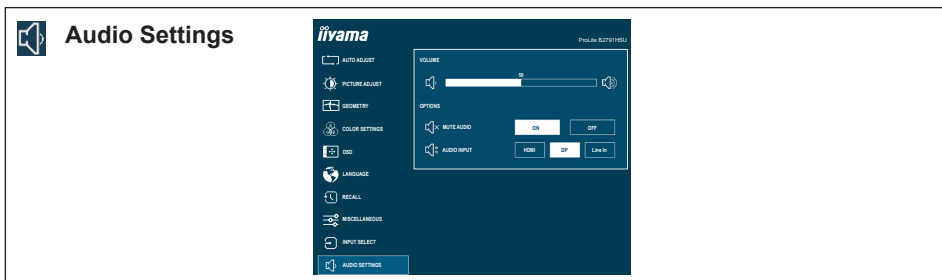

NOTE Input source is fixed and it will not be detected automatically when you select VGA, HDMI or DisplayPort.

Direct

You can skip the Menu items and directly display an option setting screen by using the following button operations.

- Input Select : Press the INPUT Button when the Menu is not displayed.



| Adjustment Item | Problem / Option | | Button to Press |
|--|----------------------|--|--|
| Volume Direct | Too soft Too loud | |   |
| Mute Audio | On | Turn off the sound temporarily. | |
| | Off | Return the sound volume to the previous level. | |
| NOTE Press the  () Button to display the volume adjustment bar and switch On and Off the Mute function by pressing the  /  Buttons. | | | |
| Audio Input * | HDMI | Select the HDMI input. | |
| | DP | Select the DisplayPort input. | |
| | LINE-IN | Select the Line-In input. | |

* For HDMI/DisplayPort inputs only.

Direct

You can skip the Menu items and directly display an adjustment scale by using the following button operations.

- Volume : Press the  Button when the Menu is not displayed.

■ Lock Mode

<OSD Menu>

The OSD can be locked to avoid an accidental setting change.

1. Make sure the monitor is turned ON.
2. The OSD lock will be activated by pressing the front ENTER Button for about 10 seconds. If you try to access the OSD by pressing any of the buttons, a message "OSD Locked" will appear on the screen.
3. The OSD lock will be deactivated by pressing the front ENTER Button again for about 10 seconds.

<Power Switch>

The Power Switch can be locked to avoid an accidental power operation.

1. Make sure the monitor is turned ON.
2. The Power Switch lock will be activated by pressing the front ◀ Button for about 10 seconds. If you try to turn off the monitor by pressing the Power Switch, a message "Power Button Locked" will appear on the screen.
3. The Power Switch lock will be deactivated by pressing the front ◀ Button again for about 10 seconds.

SCREEN ADJUSTMENTS

Adjust the image by following the procedure below to get the desired picture when selecting Analog input.

- The screen adjustments described in this manual are designed to set image position and minimize flicker or blur for the particular computer in use.
- The monitor is designed to provide the best performance at resolution of 1920 × 1080, but can not provide the best at resolutions of less than 1920 × 1080 because the picture is automatically stretched to fit the full screen. It is recommended to operate at resolution of 1920 × 1080 in normal use.
- Displayed text or lines will be blurred or irregular in thickness when the picture is stretched due to the screen enlargement process.
- It is preferable to adjust the image position and frequency with the monitor controls, rather than the computer software or utilities.
- Perform adjustments after a warm-up period of at least thirty minutes.
- Additional adjustments may be required after the Auto Adjust depending on the resolution or signal timing.
- The Auto Adjust may not work correctly when displaying the picture other than the screen adjustment pattern. In this case, manual adjustments are required.

There are two ways to adjust the screen. One way is automatic adjustment for Position, Pixel Clock and Phase. The other way is performing each adjustment manually.

Perform the Auto Adjust first when the monitor is connected to a new computer, or resolution is changed. If the screen has a flicker or blur, or the picture does not fit in the display area after performing the Auto Adjust, manual adjustments are required. Both adjustments should be made by using the screen adjustment pattern (Test.bmp) obtained via the Iiyama web site (<http://www.iiyama.com>).

Adjust the image by following the procedure below to get the desired picture.

This manual explains adjustment under Windows® OS.

- ① **Display the picture at the optimum resolution.**
- ② **Enter the Test.bmp (screen adjustment pattern) to wallpaper.**

NOTE

- Consult the appropriate documentation for doing this.
- Set the display position to center in the wallpaper setting dialogue box.

[Adjustment pattern]

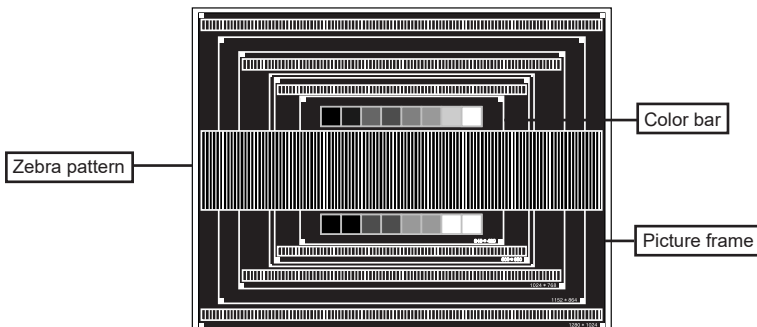

- ③ Pressing and holding of the INPUT Button for 2-3 seconds when the Menu is not displayed. (Auto Adjust)
- ④ Adjust the image manually by following procedure below when the screen has a flicker or blur, or the picture does not fit in the display area after performing the Auto Adjust.
- ⑤ Adjust the V.Position so that the top and bottom of the picture frame will fit to the display area.

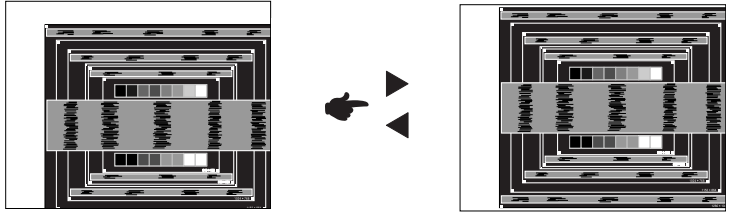

- ⑥ 1) Adjust the H.Position so that the left side of the picture frame will move to the left edge of the display area.

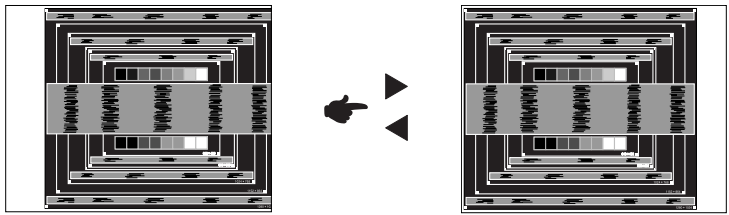

- 2) Stretch the right side of the picture frame to the right edge of the display area by adjusting the Pixel Clock.

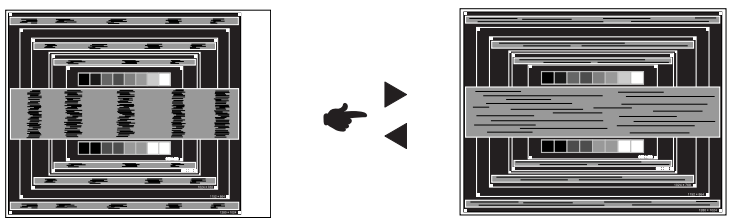

- NOTE**
- When the left side of the picture frame moves apart from the left edge of the display area during the Pixel Clock adjustment, adjust steps 1) and 2).
 - Another way to make the Pixel Clock adjustment is to correct the vertical wavy lines in the zebra pattern.
 - The picture may flicker during the Pixel Clock, H.Position and V.Position adjustment.
 - In case the picture frame is bigger or smaller than the data display area after the Pixel Clock adjustment, repeat steps from ③.

- ⑦ **Adjust the Phase to correct horizontal wavy noise, flicker or blur in the zebra pattern.**

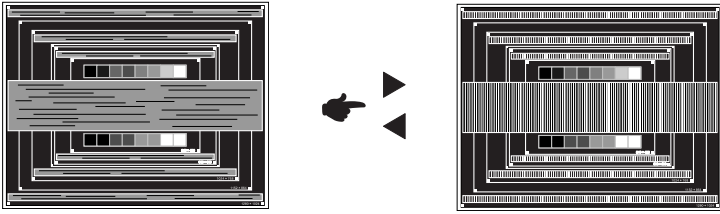

NOTE

- In case the strong flicker or blurs remain on a part of the screen, repeat steps ⑥ and ⑦ because the Pixel Clock may not be adjusted correctly.
- Adjust the H.Position after the Phase adjustment if the horizontal position moves during the adjustment.

- ⑧ **Adjust the Brightness and Color to get the desired picture after you complete the Pixel Clock and Phase adjustments.**

Put back your favorite wallpaper.

STANDBY FEATURE

The standby feature of this product complies with power saving requirement of ENERGY STAR® and VESA DPMS. When activated, it automatically reduces unnecessary power consumption of the monitor when your computer is not in use.

To use the feature, the monitor needs to be connected to a VESA DPMS compliant computer. There is a standby step the monitor takes as described below. The standby function, including any timer settings is configured by the operating system. Check your operating system manual for information on how this can be configured.

■ Standby Mode

When the video signal from the computer is off, the monitor enters into Standby Mode which reduces the power consumption to less than 0.5W*. The screen becomes dark, and the power indicator turns to orange. From Standby Mode, the image reappears in several seconds when either the keyboard or the mouse are touched again.

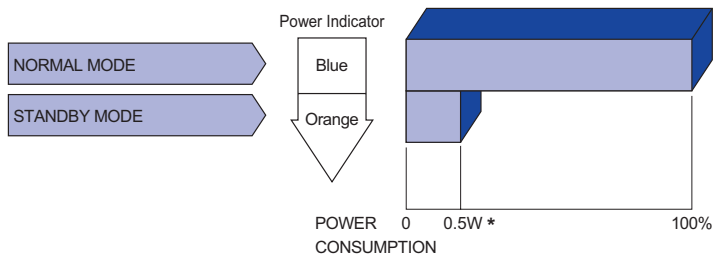

* USB peripherals and audio equipment are not connected.

NOTE

Even when using the standby mode, the monitor consumes electricity. Turn off the Power Switch whenever the monitor is not in use, during the night and weekends, to avoid unnecessary power consumption.

TROUBLE SHOOTING

If the monitor fails to operate correctly, please follow the steps below for a possible solution.

1. Perform the adjustments described in OPERATING THE MONITOR, depending on the problem you have. If the monitor does not get a picture, skip to 2.
2. Consult the following items if you cannot find an appropriate adjustment item in OPERATING THE MONITOR or if the problem persists.
3. If you are experiencing a problem which is not described below or you cannot correct the problem, discontinue using the monitor and contact your dealer or iiyama service center for further assistance.

Problem

Check

- ① The picture does not appear.

(Power indicator does not light up.)

- The Power Cable is firmly seated in the socket.
- The Power Switch is turned ON.
- The AC socket is live. Please check with another piece of equipment.

(Power indicator is blue.)

- If the blank screen saver is in active mode, touch the keyboard or the mouse.
- Increase the Contrast and/or Brightness.
- The computer is ON.
- The Signal Cable is properly connected.
- The signal timing of the computer is within the specification of the monitor.

(Power indicator is orange.)

- If the monitor is in standby mode, touch the keyboard or the mouse.
- The computer is ON.
- The Signal Cable is properly connected.
- The signal timing of the computer is within the specification of the monitor.

- ② The screen is not synchronized.

- The Signal Cable is properly connected.
- The signal timing of the computer is within the specification of the monitor.

- ③ The screen position is not in the center.

- The signal timing of the computer is within the specification of the monitor.

- ④ The screen is too bright or too dark.

- The video output level of the computer is within the specification of the monitor.

Problem

Check

- | | |
|---------------------------------------|--|
| ⑤ The screen is shaking. | <input type="checkbox"/> The power voltage is within the specification of the monitor. <input type="checkbox"/> The signal timing of the computer is within the specification of the monitor. |
| ⑥ No sound. | <input type="checkbox"/> The audio equipment (computer etc.) is ON. <input type="checkbox"/> The Audio Cable is properly connected. <input type="checkbox"/> The Volume is turned up. <input type="checkbox"/> The Mute is OFF. <input type="checkbox"/> The audio output level of the audio equipment is within the specification of the monitor. |
| ⑦ The sound is too loud or too quiet. | <input type="checkbox"/> The audio output level of the audio equipment is within the specification of the monitor. |
| ⑧ A strange noise is heard. | <input type="checkbox"/> The Audio Cable is properly connected. |

RECYCLING INFORMATION

For better environment protection please don't dispose your monitor.
Please visit our web site: www.iiyama.com for monitor recycling.

APPENDIX

Design and specifications are subject to change without prior notice.

SPECIFICATIONS : ProLite B2791HSU

ENGLISH

| | | |
|--|--|---|
| Size Category | 27" | |
| LCD Panel | Panel technology | TN |
| | Size | Diagonal: 27" (68.6cm) |
| | Pixel pitch | 0.311mm H × 0.311mm V |
| | Brightness | 300cd/m ² (Typical) |
| | Contrast ratio | 1000 : 1 (Typical), Adv. Contrast Function Available |
| | Viewable angle | Right / Left : 85 degrees each, Up / Down : 80 degrees each (Typical) |
| | Response time | 1ms (Gray to Gray) |
| Display Colors | Approx. 16.7M | |
| Sync Frequency | VGA: Horizontal: 30.0-83.0kHz, Vertical: 55-75Hz HDMI(without FreeSync): Horizontal: 30.0-84.0kHz, Vertical: 55-75Hz HDMI(with FreeSync): Horizontal: 30.0-84.0kHz, Vertical: 40-75Hz DisplayPort(without FreeSync): Horizontal: 30.0-84.0kHz, Vertical: 55-75Hz DisplayPort(with FreeSync): Horizontal: 30.0-84.0kHz, Vertical: 40-75Hz | |
| Native Resolution | 1920 × 1080, 2.1 MegaPixels | |
| Support max. resolution | VGA: 1920 × 1080 60Hz HDMI(without FreeSync): 1920 × 1080 75Hz HDMI(with FreeSync): 1920 × 1080 75Hz DisplayPort(without FreeSync): 1920 × 1080 75Hz DisplayPort(with FreeSync): 1920 × 1080 75Hz | |
| Input Connector | VGA, HDMI, DisplayPort | |
| Input Sync Signal | Separate sync: TTL, Positive or Negative | |
| Input Video Signal | Analog: 0.7Vp-p (Standard), 75Ω, Positive Digital: HDMI, DisplayPort | |
| USB Standard | USB2.0 (DC5V, 500mA) | |
| Number of USB Ports Connector shape | 1 Upstream : Series B 2 Downstream : Series A | |
| Input Audio Connector | ø 3.5mm mini jack (Stereo) | |
| Input Audio Signal | 1.0Vrms maximum | |
| Headphone Connector | ø 3.5mm mini jack (Stereo) | |
| Speakers | 2W × 2 (Stereo speakers) | |
| Maximum Screen Size | 597.60mm W × 336.15mm H / 23.5" W × 13.2" H | |
| Power Source | 100-240VAC, 50/60Hz, 1.5A | |
| Power Consumption* | 19W typical, Standby mode: 0.5W maximum | |
| Dimensions / Net Weight | 613.5× 412.0 - 542.0 × 230.0mm / 24.2 × 16.2 - 21.3 × 9.1" (W×H×D) 7.3kg / 16.1lbs | |
| Angle | Tilt: Upward: 22 degrees Downward: 5 degrees Swivel: Left/Right: 45 degrees each Rotation: Clockwise: 90° | |
| Environmental Considerations | Operating: Temperature 5 to 35°C / 41 to 95°F Humidity 10 to 80% (No condensation) Storage: Temperature -20 to 60°C / -4 to 140°F Humidity 10 to 90% (No condensation) | |
| Approvals | CE, UKCA, TÜV-GS, EAC, ENERGY STAR® | |

NOTE * USB peripherals and audio equipment are not connected.

SPECIFICATIONS : ProLite E2791HSU

| | | |
|--|--|---|
| Size Category | 27" | |
| LCD Panel | Panel technology | TN |
| | Size | Diagonal: 27" (68.6cm) |
| | Pixel pitch | 0.311mm H × 0.311mm V |
| | Brightness | 300cd/m ² (Typical) |
| | Contrast ratio | 1000 : 1 (Typical), Adv. Contrast Function Available |
| | Viewable angle | Right / Left : 85 degrees each, Up / Down : 80 degrees each (Typical) |
| | Response time | 1ms (Gray to Gray) |
| Display Colors | Approx. 16.7M | |
| Sync Frequency | VGA: Horizontal: 30.0-83.0kHz, Vertical: 55-75Hz HDMI(without FreeSync): Horizontal: 30.0-84.0kHz, Vertical: 55-75Hz HDMI(with FreeSync): Horizontal: 30.0-84.0kHz, Vertical: 40-75Hz DisplayPort(without FreeSync): Horizontal: 30.0-84.0kHz, Vertical: 55-75Hz DisplayPort(with FreeSync): Horizontal: 30.0-84.0kHz, Vertical: 40-75Hz | |
| Native Resolution | 1920 × 1080, 2.1 MegaPixels | |
| Support max. resolution | VGA: 1920 × 1080 60Hz HDMI(without FreeSync): 1920 × 1080 75Hz HDMI(with FreeSync): 1920 × 1080 75Hz DisplayPort(without FreeSync): 1920 × 1080 75Hz DisplayPort(with FreeSync): 1920 × 1080 75Hz | |
| Input Connector | VGA, HDMI, DisplayPort | |
| Input Sync Signal | Separate sync: TTL, Positive or Negative | |
| Input Video Signal | Analog: 0.7Vp-p (Standard), 75Ω, Positive Digital: HDMI, DisplayPort | |
| USB Standard | USB2.0 (DC5V, 500mA) | |
| Number of USB Ports Connector shape | 1 Upstream : Series B 2 Downstream : Series A | |
| Input Audio Connector | ø 3.5mm mini jack (Stereo) | |
| Input Audio Signal | 1.0Vrms maximum | |
| Headphone Connector | ø 3.5mm mini jack (Stereo) | |
| Speakers | 2W × 2 (Stereo speakers) | |
| Maximum Screen Size | 597.60mm W × 336.15mm H / 23.5" W × 13.2" H | |
| Power Source | 100-240VAC, 50/60Hz, 1.5A | |
| Power Consumption* | 19W typical, Standby mode: 0.5W maximum | |
| Dimensions / Net Weight | 613.5 × 440.5 × 197.0mm / 24.2 × 17.3 × 7.7" (W×H×D) 5.3kg / 11.7lbs | |
| Tilt Angle | Upward: 22 degrees Downward: 5 degrees | |
| Environmental Considerations | Operating: Temperature 5 to 35°C / 41 to 95°F Humidity 10 to 80% (No condensation) Storage: Temperature -20 to 60°C / -4 to 140°F Humidity 10 to 90% (No condensation) | |
| Approvals | CE, UKCA, TÜV-GS, EAC, ENERGY STAR® | |

NOTE * USB peripherals and audio equipment are not connected.

DIMENSIONS : ProLite B2791HSU

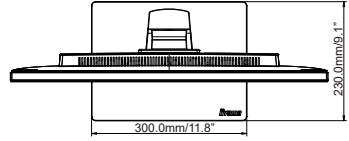
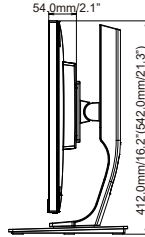
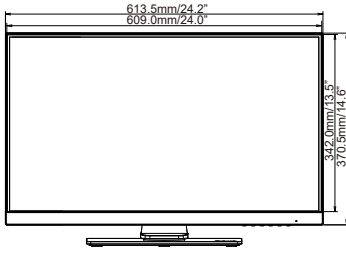

() : Maximum adjustment range

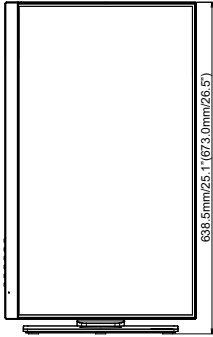

DIMENSIONS : ProLite E2791HSU

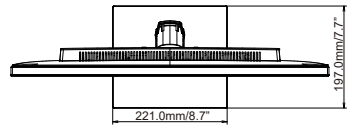
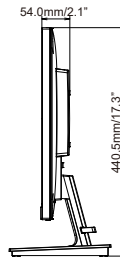
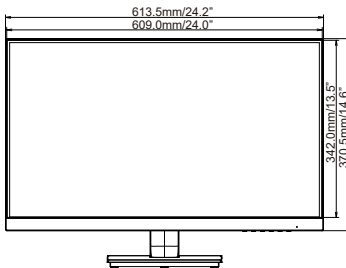

COMPLIANT TIMING

| Video Mode | Horizontal Frequency | Vertical Frequency | Dot Clock |
|-------------|----------------------|--------------------|------------|
| 640 × 480 | 31.469kHz | 59.940Hz | 25.175MHz |
| 800 × 600 | 37.879kHz | 60.317Hz | 40.000MHz |
| | 46.875kHz | 75.000Hz | 49.500MHz |
| 1024 × 768 | 48.363kHz | 60.004Hz | 65.000MHz |
| | 60.023kHz | 75.029Hz | 78.750MHz |
| 1280 × 1024 | 63.981kHz | 60.020Hz | 108.000MHz |
| | 79.976kHz | 75.025Hz | 135.000MHz |
| 1440 × 900 | 55.935kHz | 59.887Hz | 106.500MHz |
| | 70.635kHz | 74.984Hz | 136.750MHz |
| 1680 × 1050 | 65.290kHz | 60.000Hz | 146.250MHz |
| 1920 × 1080 | 66.590kHz | 59.930Hz | 138.500MHz |
| | 83.890kHz | 74.970Hz | 174.500MHz |

NOTE * HDMI and DisplayPort input only.