



Start here

[English]

Mulai dari sini

[Bahasa Indonesia]



ไทย

繁體中文

1

Fill ink tanks EN

Isi tangki tinta ID

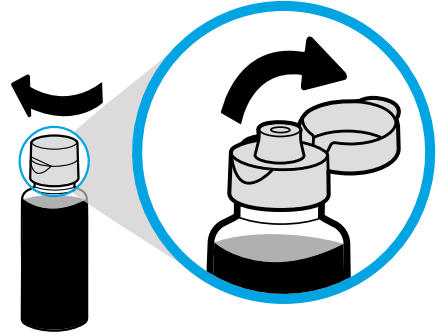
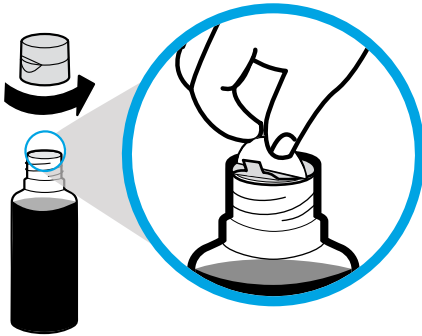
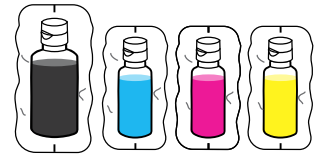

Remove black bottle cap, remove seal. Replace cap, flip lid open.

Lepas tutup botol hitam, lalu lepas segelnya. Pasang kembali tutupnya, buka penutupnya.

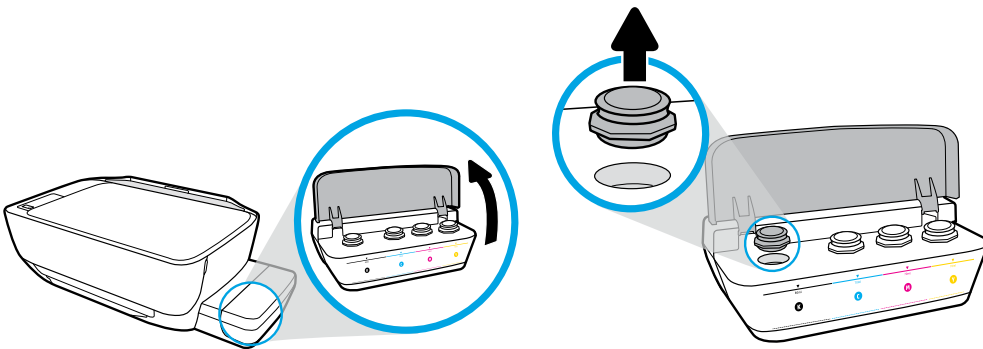

Open ink tank lid. Remove plug from black tank.

Buka tutup tangki tinta. Lepas sumbat dari tangki hitam.

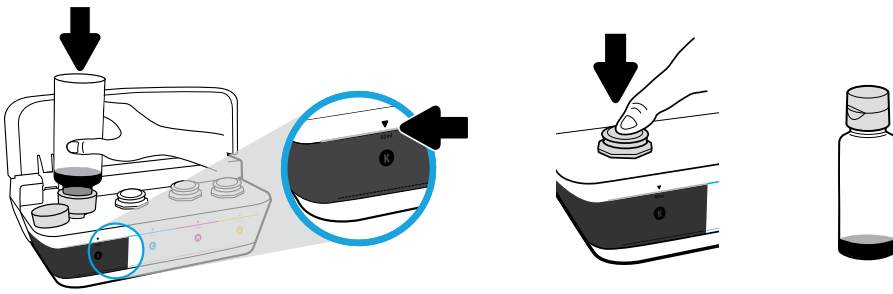

Hold bottle on tank nozzle. Fill ink to line. Replace plug and press firmly to close.

Tahan botol pada nozel tangki. Isikan tinta ke selang. Pasang kembali sumbat dan tekan kuat-kuat untuk menutupnya.

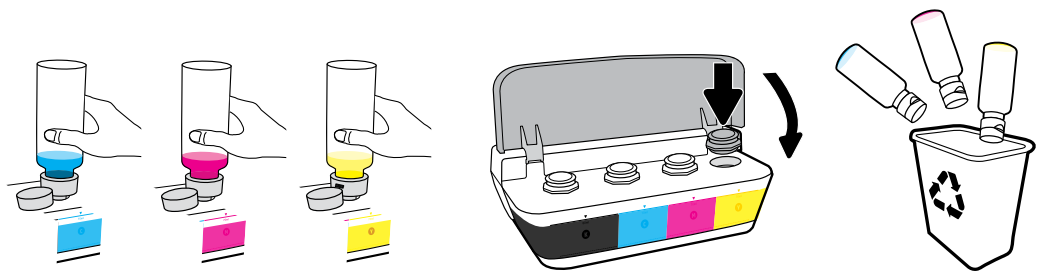

Repeat steps for each color. Close lid. Save remaining black ink for refilling.

Ulangi langkah tersebut untuk tiap warna. Tutup penutupnya. Simpan sisa tinta hitam untuk pengisian ulang.

2

Unpack and power on EN

Keluarkan dan nyalakan ID

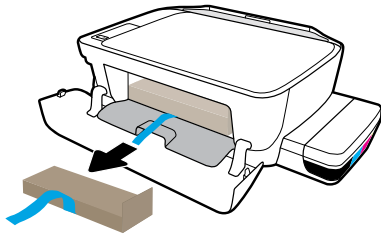
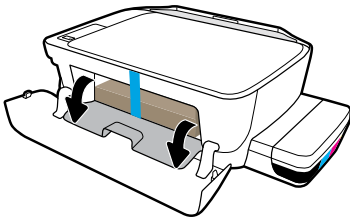
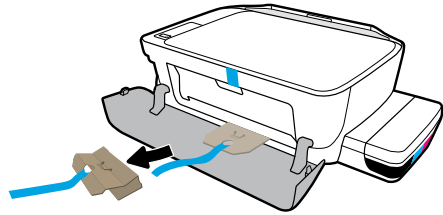
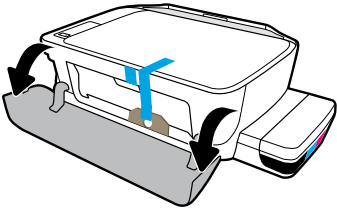

Remove packing material, tape, and two cardboard restraints.

Lepaskan bahan pembungkus, pita perekat, dan dua karton penahan.

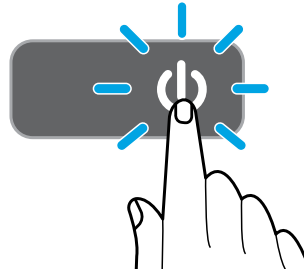
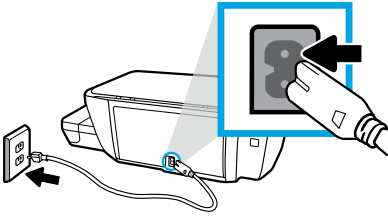

Plug in power cord and turn on printer.

Hubungkan kabel daya dan hidupkan printer.



USB



Connect USB cable only when prompted during software installation.

Hubungkan kabel USB hanya jika diminta saat penginstalan perangkat lunak.

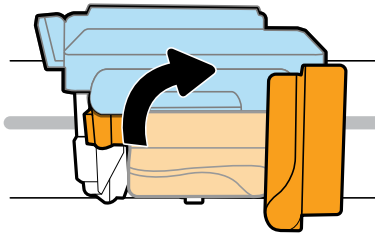
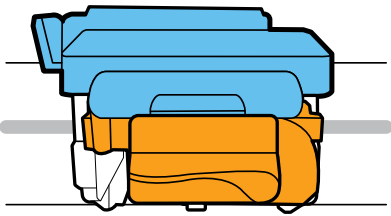
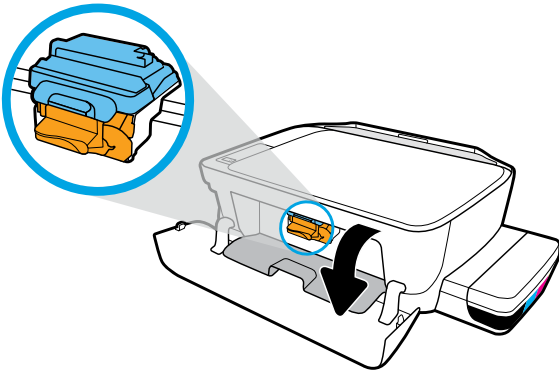

Wait for print carriage to move to center and stop. Turn orange handle.

Tunggu sampai kereta cetak bergerak ke tengah dan hentikan. Putar gagang oranye.

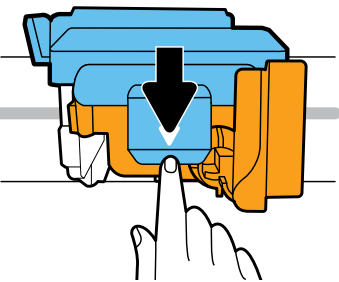

Press down on blue latch to open.

Tekan selot biru untuk membuka.

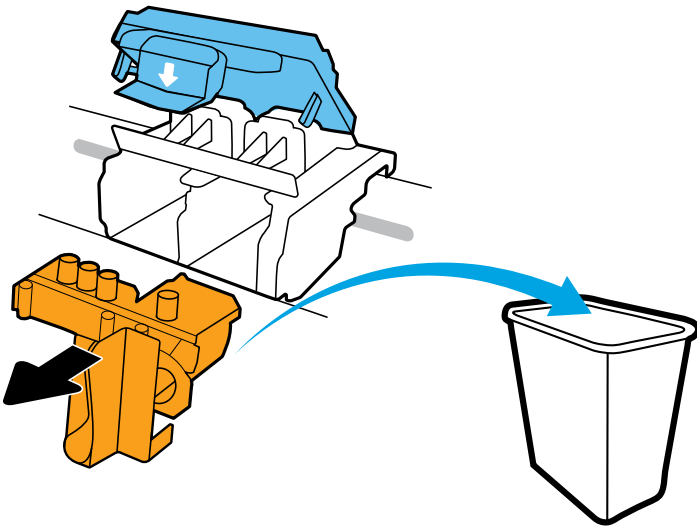

Remove and discard orange plastic piece. Handle carefully to avoid ink stains.

Lepaskan dan buang bagian plastik berwarna oranye. Pegang dengan hati-hati untuk menghindari noda tinta.

3

Install printheads EN

Memasang kepala cetak ID

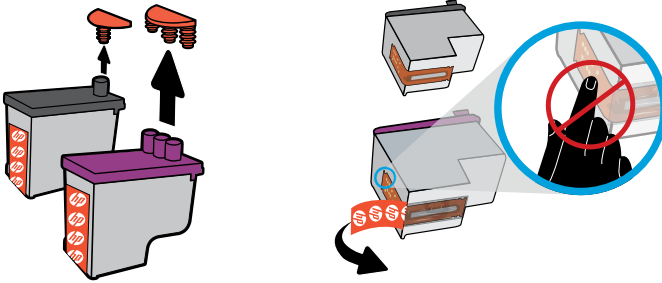
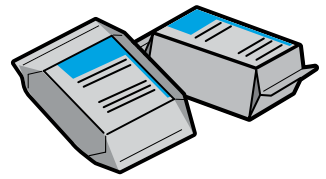

Remove plugs from tops of printheads, then remove tape from contacts using pull tabs.

Cabut sumbat dari bagian atas kepala cetak, lalu lepas pita perekat dengan menggunakan tab penarik.

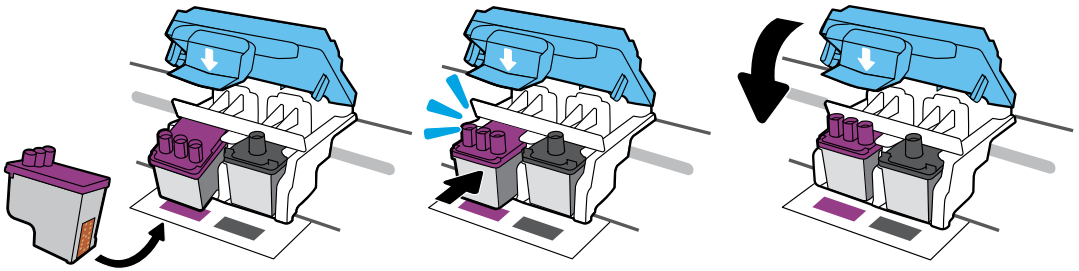

Slide in printheads until they snap. Firmly close blue latch.

Geser kepala cetak ke dalam hingga terpasang. Tutup selot biru dengan kuat.

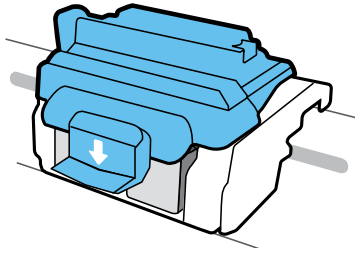

IMPORTANT! Keep blue latch closed after printhead installation.

PENTING! Tutup selot biru setelah memasang kepala cetak.

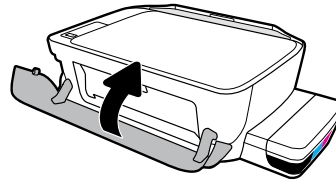
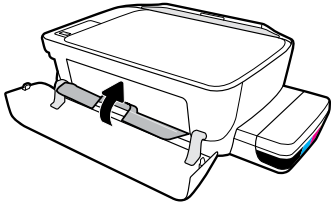

Close printhead access door, then close front door.

Tutup pintu akses kepala cetak, lalu tutup pintu depan.

4

Load paper EN

Memasukkan kertas ID

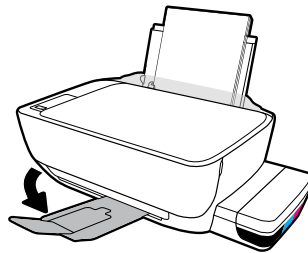
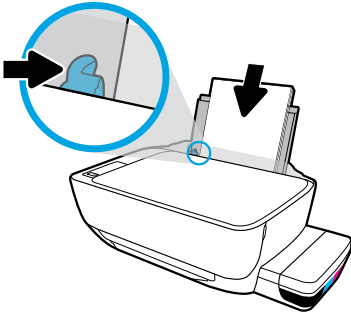
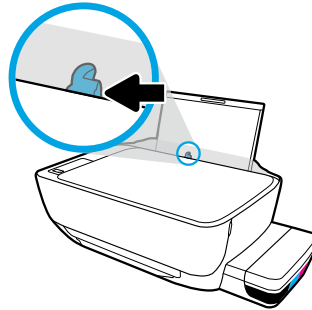
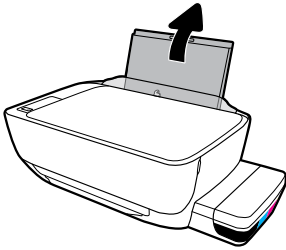

Pull out input tray. Load plain white paper and adjust guide. Pull out output tray and extender.

Tarik keluar baki masukan. Muatkan kertas putih dan sesuaikan pemandunya. Tarik keluar baki keluaran dan pemanjangan.

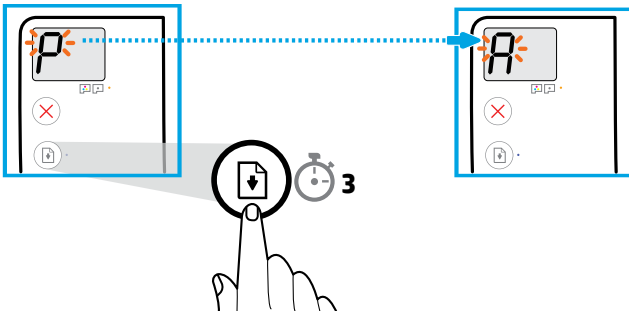

Press  (Resume) for 3 seconds. Wait for alignment page to print when blinking “P” becomes “A”.

Tekan  (Lanjutkan) selama 3 detik. Tunggu hingga halaman penyejajaran dicetak saat “P” yang berkedip berubah menjadi “A”.

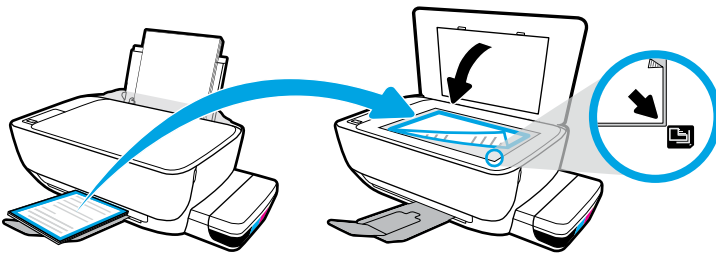

Place alignment page on scanner glass.

Tempatkan halaman penyejajaran di atas kaca pemindai.

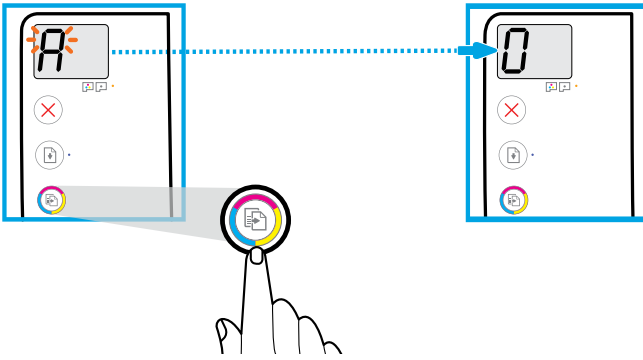

i Printer might make faint sounds temporarily.

Printer mungkin akan mengeluarkan suara samar untuk sementara.

Press  (Color Copy) to complete printhead alignment. Continue setup when “A” becomes “0”.

Tekan  (Salinan Warna) untuk menyelesaikan penyetaraan kepala cetak. Lanjutkan pengesetan saat “A” menjadi “0”.

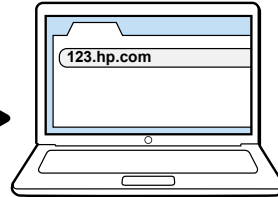
123.hp.com →

Enter **123.hp.com** in a web browser on your computer to download and install the HP printer software.

Note for Windows® users: You can also order a printer software CD at www.support.hp.com.

Register your printer online during software installation. You can also learn about registration at www.register.hp.com.

Masukkan **123.hp.com** ke browser web pada komputer Anda untuk mengunduh dan menginstal perangkat lunak printer HP.

Catatan untuk pengguna Windows®: Anda juga dapat memesan CD perangkat lunak printer di www.support.hp.com.

Daftarkan printer Anda secara online selama penginstalan perangkat lunak. Anda juga dapat mempelajari tentang pendaftaran di www.register.hp.com.



IMPORTANT: Read following pages to prevent damage to your printer.

PENTING: Baca halaman berikut untuk mencegah kerusakan pada printer Anda.



Always maintain proper ink levels EN

Selalu pertahankan level tinta yang tepat ID

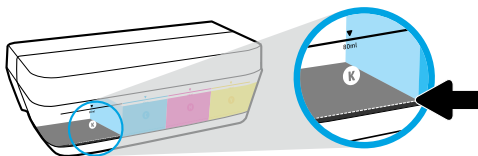

Always refill ink before it falls below lower line.

Selalu isi ulang tinta sebelum mencapai garis paling bawah.

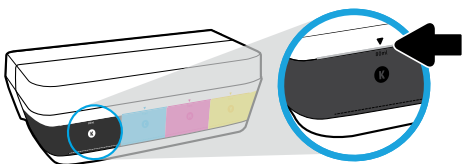

Fill ink to upper line. Some ink might be left in the bottles.

Isikan tinta ke selang atas. Tinta mungkin tersisa di dalam botol.

 Product service or repairs required as a result of filling the ink tanks improperly and/or using non-HP ink will not be covered under warranty.

Servis atau perbaikan produk yang diperlukan akibat pengisian tangki tinta yang tidak benar dan/atau penggunaan tinta non-HP tidak tercakup dalam jaminan.



Keep latch closed EN

Biarkan selot tertutup ID

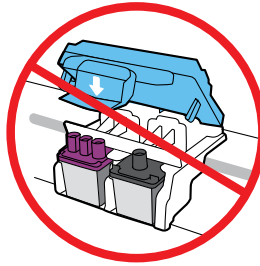
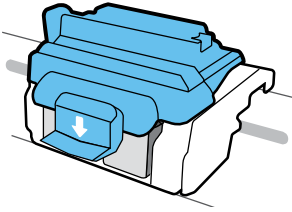

After setup, do not open the blue latch unless installing new printheads or moving printer outside home or office.

Setelah pengesetan, jangan buka selot biru, kecuali jika ingin memasang kepala cetak yang baru atau memindahkan printer dari rumah atau kantor.



Moving printer after setup EN

Memindahkan printer setelah pengesetan ID

Short Distance: If you are moving the printer within your home or office, keep blue latch closed, and keep printer level.

Long Distance: If you are moving the printer outside your home or office, visit www.support.hp.com or contact HP.

Jarak Pendek: Jika Anda memindahkan printer dari rumah atau kantor, pertahankan agar selot biru tetap tertutup, dan pertahankan level printer.

Jarak Jauh: Jika Anda memindahkan printer keluar rumah atau kantor Anda, kunjungi www.support.hp.com atau hubungi HP.
