

# SENCOR®

STS 7500WH  
STS 7501BK



TOASTER

Translation of the original manual



**SENCOR®**

**STS 7500WH  
STS 7501BK**



**A**

**1**

**2**

**3**

**4**

**5**

**7**

**6**

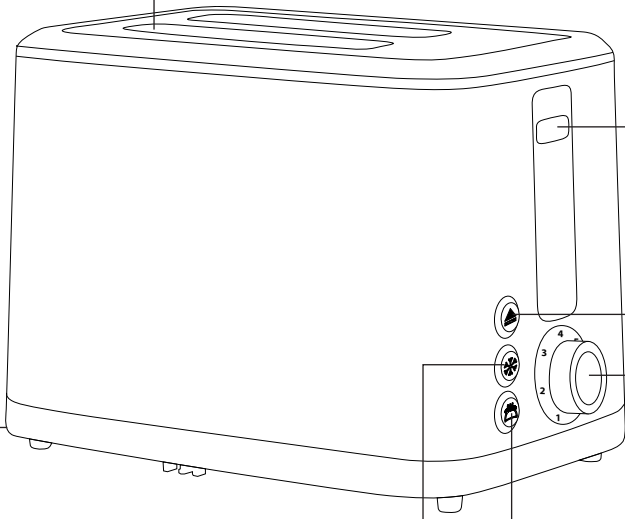

## Important Safety Instructions

### **READ CAREFULLY AND STORE FOR FUTURE USE.**

- This appliance may be used by children 8 years of age and older and by persons with physical, sensory or mental impairments or by inexperienced persons, if they are properly supervised or have been informed about how to use of the product in a safe manner and understand the potential dangers.
- Children must not play with the appliance.
- Cleaning and maintenance must not be performed by children unless they are older than 8 years of age and under supervision.
- Children under 8 years of age must be kept away from the appliance and its power cord.
- If the power cord is damaged, have it replaced in a professional service centre in order to prevent a dangerous situation. It is forbidden to use the appliance with the power cord damaged.
- The temperature of accessible surfaces may be higher if the appliance is in operation.
- The bread may catch on fire, so do not use the appliance near or under flammable material such as curtains.

- Clean surfaces that come into contact with food according to the instructions in the chapter "Cleaning and Maintenance". The removable tray must be cleaned regularly to prevent the accumulation of crumbs. When cleaning, follow the instructions in the chapter "Cleaning and maintenance".
- This appliance is not designed to be controlled using an external timer switch or a remote control.



### **Caution: Hot surface**

The temperature of accessible surfaces may be higher if the appliance is in operation. Such surfaces can become hot during use. Do not touch hot surface. This could cause skin burns.

- This product is designed for household use only. The appliance is also designed for personal non-commercial use in areas that include, but are not limited to the following:
  - staff kitchenettes in stores, offices and other workplaces;
  - hotel or motel rooms and other living areas;
  - agricultural farms;
  - bed and breakfast establishments.
- The appliance is used for toasting baked goods such as toasted bread, ordinary consumer bread, buns, bagels, etc.
- Do not use the appliance in an industrial environment or outdoors or for purposes other than those for which it is intended.
- Do not use the appliance to bake sweet pastries that are sprinkled with sugar or contain jam, jam or marmalade, such as cakes, buns, etc. Otherwise a fire may result.
- Before connecting this appliance to a power socket, make sure the voltage stated on its rating label corresponds to the voltage in power socket. Connect the appliance only to a grounded power socket.
- Fully unwind the power cord before using the appliance. Make sure the power cord does not hang over the edge of a table and that it is not touching a hot surface.
- Do not place the appliance on or near an electric or gas hob, table edge, sink draining board or unstable surfaces. The appliance must be located on a stable and even surface.
- In terms of fire safety, this appliance complies with the standards in force in the European Union. Within the meaning of these standards, these are appliances that can be operated on a table or similar surface, provided that a safe distance of at least 50 cm is maintained from combustible material surfaces in the direction of main radiation and at least 10 cm in other directions.
- Do not use the appliance without the crumb tray properly inserted.
- Before using the appliance for the first time, it must be idled at least three times at the maximum toasting setting to get rid of any odour.
- Do not leave the appliance unattended when in use.
- Never cover the appliance when it is in operation or warm.
- Do not insert excessively large pieces of bread, bread wrapped in aluminium foil or metal objects into the toasting slots. Otherwise, fire or electric shock may result.
- Special care must be taken when removing smaller pieces of bread from the appliance to prevent burns.
- Never bake bread by placing it horizontally directly on the toasting slots. This would disrupt the air circulation and could cause a fire.
- Never attempt to remove blocked toast, bagel or other baked goods with a knife or other metal object; damage to the heating elements, serious malfunction of the appliance, or electric shock could result. Let the appliance cool down, pull the power cord out of the socket and carefully remove the blocked piece of bread.
- Do not remove the bread while the appliance is in operation.
- Use only the accessories supplied with the appliance.
- To prevent potential injury by electric shock, do not submerge this appliance or its power cord under water or any other liquid.
- Always switch off the appliance and unplug it from the mains socket when leaving it unattended or when not in use, before cleaning and moving it. Allow the appliance to cool completely before moving, cleaning and storing.

- Unplug the appliance from the power socket by pulling the plug, not the power cord. Otherwise, damage to the power cord or the socket could occur.
- Do not use the appliance if it is damaged, if it is not working properly, if it has been dropped on the ground or immersed in water. To prevent dangerous situations, do not repair or modify the appliance yourself. Have all repairs or adjustments performed at an authorised service centre. By tampering with the appliance, you expose yourself to the risk of losing your legal rights regarding faulty performance or warranty for quality.

# EN Toaster User's Manual

- Thank you for purchasing our SENCOR product; we hope you will be satisfied with it.
  - Before using this appliance, please familiarise yourself with the user's manual, even if you are already familiar with using similar types of appliances. Use the appliance only as described in this user's manual. Keep the manual for future reference.
  - We recommend to keep the original packaging, packaging materials, receipt, and proof of the seller's liability or warranty certificate for a minimum of the duration of statutory right of faulty performance or warranty of quality. When transporting the appliance, we recommend packaging it again in the original box provided by the manufacturer.
8. The toaster will automatically turn off and eject the inserted bread as soon as the toasting process is completed. Remove the bread from the toaster and repeat the above procedure to toast the other bread.



#### Note:



To remove smaller pieces of bread, lift the control lever all the way up.



#### Warning:

Never attempt to take out a jammed piece of bread or any other bread product using a knife or another metal object. This could lead to injury by electrical shock or damage the appliance. If the bread is blocked inside the toaster, turn it off, disconnect it from the power socket and let it cool down. Then carefully remove the bread.

## DESCRIPTION OF THE APPLIANCE

- |   |  |
|---|--|
| <b>A1</b> Toasting slots  | <b>A5</b> Rotary control for toasting intensity / cancelling toasting  |
| <b>A2</b> Detachable crumb tray   | <b>A6</b>  button for bread heating       |
| <b>A3</b> Control lever   | <b>A7</b>  button for baking frozen bread |
| <b>A4</b>  button to stop the toasting process immediately |  |

## BEFORE FIRST USE

- Before first use, remove the appliance and its accessories from the packaging and remove all promotional labels and tags.
- Before first use, the toaster must be run at least three times at the maximum toasting setting to get rid of any odour.

## OPERATING THE APPLIANCE

1. Place the toaster on a flat, dry and stable surface well away from combustible material surfaces as specified in the Safety Instructions section.
2. Unwind the power cord completely and connect the toaster to a power socket.
3. Make sure the crumb tray is inserted correctly.
4. Insert a slice of toast bread, a slice of regular bread, half a bun or bagel, etc. into each slot. The slices of bread must not be too thick to avoid getting stuck in the slots and should not protrude from the toaster when the control lever is in the down position.



#### Warning:

Do not put bread covered with butter, margarine, etc. in the toaster.

5. Use the rotary control to adjust the toasting intensity from 1 to 7, where setting 1 is the lightest toasting intensity and 7 is the darkest toasting intensity. For the first use, we recommend setting the toasting intensity to level 3. You can adjust the toasting intensity according to your personal preferences. The toasting intensity cannot be changed during the toasting process.
6. Put the toaster into operation by pushing down the control lever. After the lever is secured in the lower position, the toasting process will start automatically.



#### Note:

If the toaster is not connected to a power socket, the lever will not be locked in the down position and thus will not be started.

7. During the toasting process, you can check the state of toasting by lifting the control lever upwards. If necessary, you can cancel the toasting process by pressing .

- After use, unplug the toaster from the power outlet and let it cool down.

## Bread Heating Function

- This function allows you to heat the bread without further toasting.
- Insert the bread into the slots and press the control lever down until it locks in the lower position. Press . The button will light up.
- The toaster automatically switches off and ejects the inserted bread once the heating process is complete. Remove the bread from the toaster and repeat the above procedure to heat the other breads.



#### Note:

The heating time is preset from the factory and cannot be adjusted. If you need to cancel the heating process, press the button .

## Frozen Bread Toasting Function

- Insert the frozen bread into the slots, set the desired degree of toasting and press the control lever down until it locks in the lower position. Press the  button. The button will light up.
- The toaster will automatically turn off and eject the inserted bread as soon as the toasting process is completed. Remove the bread from the toaster and repeat the above procedure to toast the frozen bread.



#### Note:

If you need to cancel the toasting process of the frozen bread, press .



#### Warning:

The toasting function for frozen bread and the heating function for bread cannot be selected at the same time.

## Tips and Tricks to Set the Toasting Intensity

- Toasting is a two-step process. The first phase evaporates the moisture from the bread and the second phase toasts it.
- The toasting level depends on the type, size and freshness of the bread.
- Fresh bread will be toasted longer, because the moisture contained in it must first evaporate and only then it begins to be toasted. Therefore, it requires setting a higher level of toasting intensity. Wholemeal bread, thicker slices of bread, sliced buns and baguettes also require a higher toasting setting.

- Older bread, which does not contain as much moisture as fresh bread, will toast for a shorter time and therefore requires a lower than normal toasting intensity setting.
- Smaller and weaker slices of bread will toast faster than larger and thicker slices of bread.
- If you are toasting only one slice of bread, set a lower toasting level than if you are toasting two slices at the same time.

.....

**CLEANING AND MAINTENANCE**

- Clean the toaster after each use. Before cleaning, make sure that it is unplugged from the power outlet and that it is cool.
- Slide the crumb tray out of the toaster and remove the crumbs, wipe it with a clean, dry cloth and put it back in place. Clean the crumb tray after each use of the toaster. Make sure that crumbs do not accumulate in it. Otherwise, they could burst into flames.
- To remove crumbs from the inner compartment, turn the toaster upside down and carefully shake out the crumbs above the rubbish bin.
- Wipe the outer surface of the toaster with a dry or slightly damp cloth and then wipe it dry. Make sure that no water or moisture leaks into the inside of the toaster.
- Do not use cleaning products causing abrasion, petrol or solvents for cleaning.
- To prevent potential injury by electric shock, do not submerge this appliance or its power cord under water or any other liquid.

.....

**TECHNICAL SPECIFICATIONS**

Rated voltage range.....220–240V-  
 Rated frequency.....50–60 Hz  
 Rated power input.....780–930 W

We reserve the right to change the text and technical specifications.

.....

**INSTRUCTIONS AND INFORMATION ON DISPOSAL OF USED PACKAGING MATERIAL**

Dispose of used packaging material at a site designated for waste in your municipality.

**DISPOSING OF USED ELECTRICAL AND ELECTRONIC EQUIPMENT**



This symbol on the products or accompanying documents indicates that used electrical and electronic products should not be disposed of with regular municipal waste.

For proper disposal and recycling, take these products to designated collection points. Or in some European Union states or other European countries the products can be returned to the local retailer when buying an equivalent new product. Disposing of this product correctly helps save

valuable natural resources and prevents damage to the environment by improper waste disposal. Ask your local authorities or collection facility for more details. In accordance with national regulations penalties may be imposed for the incorrect disposal of this type of waste.

**For Business Entities in European Union States**

If you want to dispose of electric or electronic devices, ask your retailer or supplier for the necessary information.

**Disposal in Other Countries Outside the European Union**

This symbol is valid in the European Union. If you wish to dispose of this product, request the necessary information about the correct disposal method from the local council or from your retailer.



This product complies with all the essential requirements of the EU directives that apply to it.



