

**RPT4545M**  
**RPT4545E**



## IMPORTANT!

It is essential that you read the instructions in this manual before assembling, operating, and maintaining the product.

Subject to technical modification.

Safety, performance, and dependability have been given top priority in the design of your electric pole hedge trimmer.

## INTENDED USE

The electric pole hedge trimmer is intended to cut and trim hedge, shrubs, and similar vegetation.

The product is designed for home or domestic use. The product is intended only for outdoor use in dry and well-illuminated conditions.

Do not use the product for any other purpose.

## GENERAL PRODUCT SAFETY WARNINGS

**⚠ WARNING! Read all safety warnings, instructions, illustrations and specifications provided with this power tool.** Failure to follow all instructions listed below may result in electric shock, fire, and/or serious injury.

**Save all warnings and instructions for future reference.**

The term "power tool" in the warnings refers to your mains-operated (corded) product or battery-operated (cordless) product.

## WORK AREA SAFETY

- **Keep work area clean and well lit.** Cluttered or dark areas invite accidents.
- **Do not operate power tools in explosive atmospheres, such as in the presence of flammable liquids, gases or dust.** Power tools create sparks which may ignite the dust or fumes.
- **Keep children and bystanders away while operating a power tool.** Distractions can cause you to lose control.

## ELECTRICAL SAFETY

- **Power tool plugs must match the outlet. Never modify the plug in any way. Do not use any adapter plugs with earthed (grounded) power tools.** Unmodified plugs and matching outlets will reduce risk of electric shock.
- **Avoid body contact with earthed or grounded surfaces, such as pipes, radiators, ranges and refrigerators.** There is an increased risk of electric shock if your body is earthed or grounded.
- **Do not expose power tools to rain or wet conditions.** Water entering a power tool will increase the risk of electric shock.
- **Do not abuse the cord. Never use the cord for carrying, pulling or unplugging the power tool. Keep cord away from heat, oil, sharp edges or moving parts.** Damaged or entangled cords increase the risk of electric shock.
- **When operating a power tool outdoors, use an extension cord suitable for outdoor use.** Use of a cord suitable for outdoor use reduces the risk of electric shock.
- **If operating a power tool in a damp location is unavoidable, use a residual current device (RCD)**

**protected supply.** Use of an RCD reduces the risk of electric shock.

## PERSONAL SAFETY

- **Stay alert, watch what you are doing and use common sense when operating a power tool. Do not use a power tool while you are tired or under the influence of drugs, alcohol or medication.** A moment of inattention while operating power tools may result in serious personal injury.
- **Use personal protective equipment. Always wear eye protection.** Protective equipment such as a dust mask, non-skid safety shoes, hard hat or hearing protection used for appropriate conditions will reduce personal injuries.
- **Prevent unintentional starting. Ensure the switch is in the off-position before connecting to power source and/or battery pack, picking up or carrying the tool.** Carrying power tools with your finger on the switch or energising power tools that have the switch on invites accidents.
- **Remove any adjusting key or wrench before turning the power tool on.** A wrench or a key left attached to a rotating part of the power tool may result in personal injury.
- **Do not overreach. Keep proper footing and balance at all times.** This enables better control of the power tool in unexpected situations.
- **Dress properly. Do not wear loose clothing or jewellery. Keep your hair and clothing away from moving parts.** Loose clothes, jewellery or long hair can be caught in moving parts.
- **If devices are provided for the connection of dust extraction and collection facilities, ensure these are connected and properly used.** Use of dust collection can reduce dust-related hazards.
- **Do not let familiarity gained from frequent use of tools allow you to become complacent and ignore tool safety principles.** A careless action can cause severe injury within a fraction of a second.

## POWER TOOL USE AND CARE

- **Do not force the power tool. Use the correct power tool for your application.** The correct power tool will do the job better and safer at the rate for which it was designed.
- **Do not use the power tool if the switch does not turn it on and off.** Any power tool that cannot be controlled with switch is dangerous and must be repaired.
- **Disconnect the plug from the power source and/or remove the battery pack, if detachable, from the power tool before making any adjustments, changing accessories, or storing power tools.** Such preventive safety measures reduce the risk of starting the power tool accidentally.
- **Store idle power tools out of the reach of children and do not allow persons unfamiliar with the power tool or these instructions to operate the power tool.** Power tools are dangerous in the hands of untrained users.
- **Maintain power tools and accessories. Check for misalignment or binding of moving parts, breakage of parts and any other condition that may affect the power tool's operation. If damaged, have the power tool repaired before use.** Many accidents are caused by poorly maintained power tools.

- **Keep cutting tools sharp and clean.** Properly maintained cutting tools with sharp cutting edges are less likely to bind and are easier to control.
- **Use the power tool, accessories and tool bits etc. in accordance with these instructions, taking into account the working conditions and the work to be performed.** Use of the power tool for operations different from those intended could result in a hazardous situation.
- Keep handles and grasping surfaces dry, clean and free from oil and grease. Slippery handles and grasping surfaces do not allow for safe handling and control of the tool in unexpected situations.

## SERVICE

- **Have your power tool serviced by a qualified repair person using only identical replacement parts.** This will ensure that the safety of the power tool is maintained.

## POLE HEDGE TRIMMER SAFETY WARNINGS

- **Do not use the hedge trimmer in bad weather conditions, especially when there is a risk of lightning.** This decreases the risk of being struck by lightning.
- **Keep all power cords and cables away from cutting area.** Power cords or cables may be hidden in hedges or bushes and can be accidentally cut by the blade.
- **Wear ear protection.** Adequate protective equipment will reduce the risk of hearing loss.
- **Hold the hedge trimmer by insulated gripping surfaces only, because the blade may contact hidden wiring or its own cord.** Blades contacting a "live" wire may make exposed metal parts of the hedge trimmer "live" and could give the operator an electric shock.
- **Keep all parts of the body away from the blade. Do not remove cut material or hold material to be cut when blades are moving.** Blades continue to move after the switch is turned off. A moment of inattention while operating the hedge trimmer may result in serious personal injury.
- **When clearing jammed material or servicing the hedge trimmer, make sure all power switches are off and the power cord is disconnected.** Unexpected actuation of the hedge trimmer while clearing jammed material or servicing may result in serious personal injury.
- **Carry the hedge trimmer by the handle with the blade stopped and taking care not to operate any power switch.** Proper carrying of the hedge trimmer will decrease the risk of inadvertent starting and resultant personal injury from the blades.
- **When transporting or storing the hedge trimmer, always use the blade cover.** Proper handling of the hedge trimmer will decrease the risk of personal injury from the blades.
- **To reduce the risk of electrocution, never use the pole hedge trimmer near any electrical power lines.** Contact with or use near power lines may cause serious injury or electric shock resulting in death.
- **Always use two hands when operating the pole hedge trimmer.** Hold the pole hedge trimmer with both hands to avoid loss of control.
- **Always use head protection when operating the pole hedge trimmer overhead.** Falling debris can result in serious personal injury.

## ADDITIONAL SAFETY WARNINGS

- Do not attempt to cut stems or twigs that are larger than 20 mm thick, or are obviously too large to feed into the cutting blade. Use a non-powered hand saw or pruning saw to trim large stems.
- Check the hedges and bushes for foreign objects, such as wire fences and hidden wiring.
- Electrical power should be supplied via a residual current device (RCD) with a tripping current of not more than 30 mA.
- While operating the product, always hold it firmly with both hands by the two handles.
- The product must be used only at ground level and not on a ladder or any other unstable support.
- Inspect the product before each use. Check for loose fasteners. Make sure that all guards and handles are properly and securely attached. Replace any damaged parts before use.
- Do not operate the product in poor lighting. The operator requires a clear view of the work area to identify potential hazards.
- The use of hearing protection may restrict the operator's ability to hear warning sounds. Pay particular attention to potential hazards around and inside the working area.
- Turn off the product, disconnect it from the power supply, and allow it to cool down. Make sure that all moving parts have come to a complete stop:
  - before adjusting the working position of the cutting means
  - before servicing
  - before clearing a blockage
  - before checking, cleaning, or working on the product
  - before changing accessories
  - before leaving the product unattended
  - before checking for damage after striking a foreign object
  - before performing maintenance
  - whenever the product starts to vibrate abnormally
- Do not force the product through heavy shrubbery. This can cause the blades to bind and slow down. If the blades slow down, reduce the pace.
- If the product is dropped, suffers heavy impact, or begins to vibrate abnormally, immediately turn off the product and inspect it for damage or identify the cause of the vibration. Any damage should be properly repaired or replaced by an authorised service centre.
- Do not wear multiple belt or shoulder harnesses.
- Operate the product only in temperatures between 0 °C and 40 °C.
- Store the product in a location where the ambient temperature is between 0 °C and 40 °C.
- Injuries may be caused, or aggravated, by prolonged use of the product. When using the product for prolonged periods, ensure to take regular breaks.

## TRANSPORTATION AND STORAGE

- Turn off the product and disconnect it from the power supply. Make sure that all moving parts have come to a complete stop. Allow the product to cool down before storing or transporting.
- Remove all foreign materials from the product. Store the product in a cool, dry, and well-ventilated place that is

inaccessible to children. Keep the product away from corrosive agents, such as garden chemicals and de-icing salts. Do not store the product outdoors.

- Fit the blade cover before storing the product or during transportation.
- For transportation, secure the product against movement or falling to prevent injury to persons or damage to the product.

### MAINTENANCE

- Use only original manufacturer's replacement parts, accessories, and attachments. Failure to do so can cause possible injury, can contribute to poor performance, and may void your warranty.
- Servicing requires extreme care and knowledge and should be performed only by a qualified service technician. Have the product serviced by an authorised service centre only.
- The blades are extremely sharp. To prevent personal injury, exercise extreme caution when cleaning, lubricating, fitting, or removing the blade cover.
- You may make adjustments and repairs described in this manual. For other repairs, have the product serviced by an authorised service centre only.
- After each use, clean the body and handles of the product with a soft, dry cloth. Any part that is damaged should be properly repaired or replaced by an authorised service centre.
- After each use, remove the debris from the blades with a stiff brush, and then carefully apply a rust preventative lubricant before refitting the blade cover. Use a rust preventative lubricant spray to apply an even distribution and reduce the risk of personal injury from contact with the blades. For information about a suitable spray product, check with an authorised service centre.
- Check all nuts, bolts, and screws at frequent intervals for proper tightness to ensure that the product is in safe working condition. Any part that is damaged should be properly repaired or replaced by an authorised service centre.

### KNOW YOUR PRODUCT

See page 5.

1. Blade
2. Pivoting button
3. Extension pole
4. Harness hanger
5. Front handle
6. Shaft coupling
7. Trigger release
8. On/Off trigger
9. Cord retainer
10. Harness
11. Blade cover
12. Operator's manual

### SYMBOLS



Safety alert



Read and understand all instructions before operating the product. Follow all warnings and safety instructions.



Wear eye, ear, and head protection.



Wear non-slip safety footwear when using the product.



Wear non-slip, heavy duty gloves.



Do not expose the product to rain or damp conditions.



To prevent serious injury, do not touch the cutting blades.

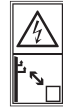

Keep sufficient distance away from electrical power lines.



Disconnect the plug from the power outlet immediately before maintenance or if the cable is damaged or cut.



Beware of thrown or flying objects. Keep all bystanders, especially children and pets, at least 15 m away from the operating area.



Class II: Protection against electric shock relies on double insulation or reinforced insulation.



Guaranteed sound power level



Do not dispose of waste electrical and electronic equipment as unsorted municipal waste. Waste electrical and electronic equipment must be collected separately. Waste light sources have to be removed from the equipment. Check with your local authority or retailer for recycling advice and collection point. According to local regulations, retailers may have an obligation to take back waste electrical and electronic equipment free of charge. Your contribution to the reuse and recycling of waste electrical and electronic equipment helps to reduce the demand of raw materials. Waste electrical and electronic equipment contain valuable and recyclable materials, which can adversely impact the environment and the human health if not disposed of in an environmentally compatible manner. Delete personal data from waste equipment, if any.

RPT4545M

RPT4545E

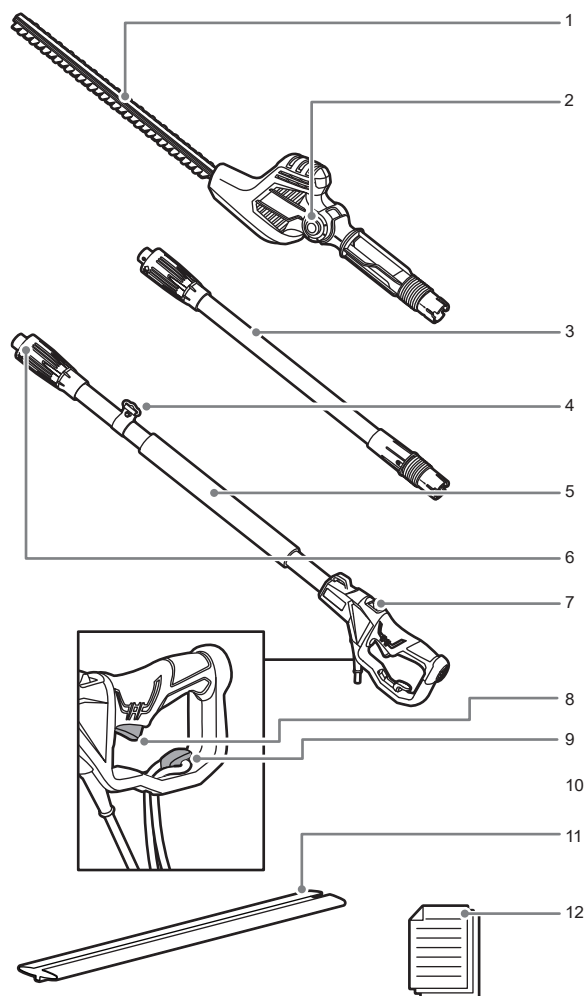

RPT4545M

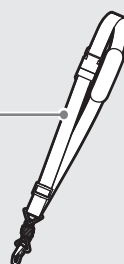

RPT4545E

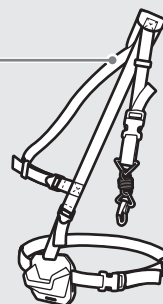

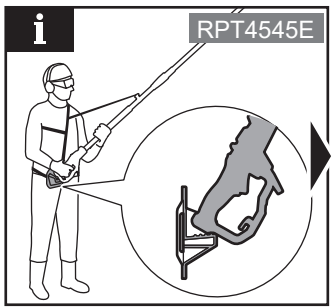
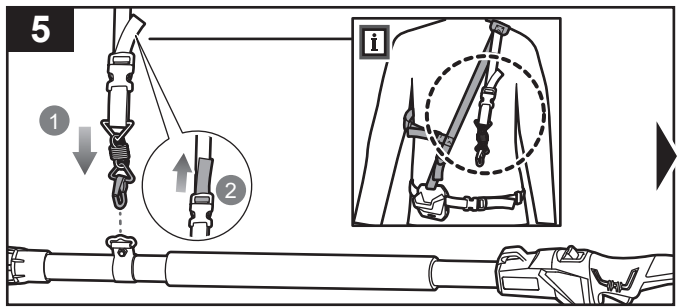
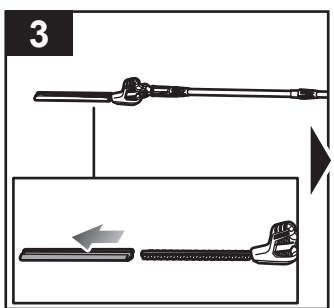
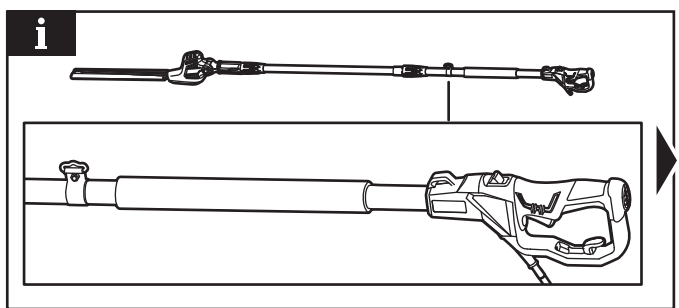
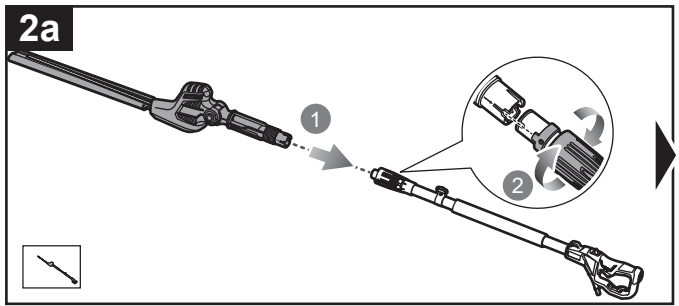
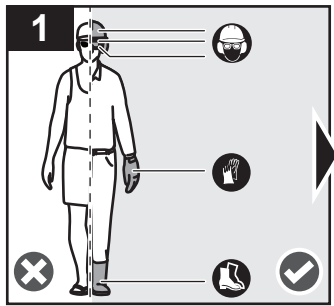

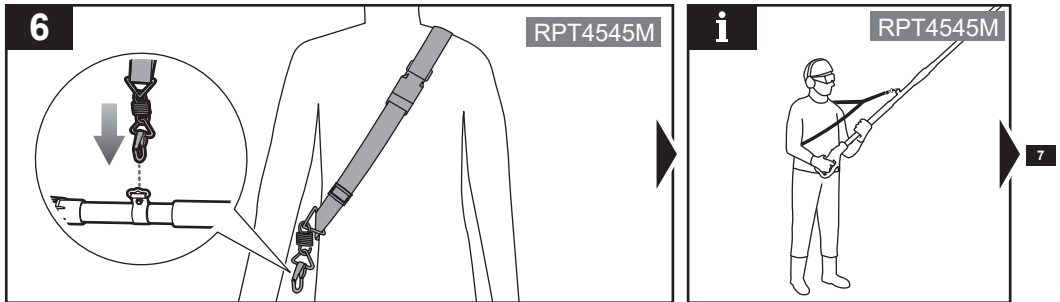
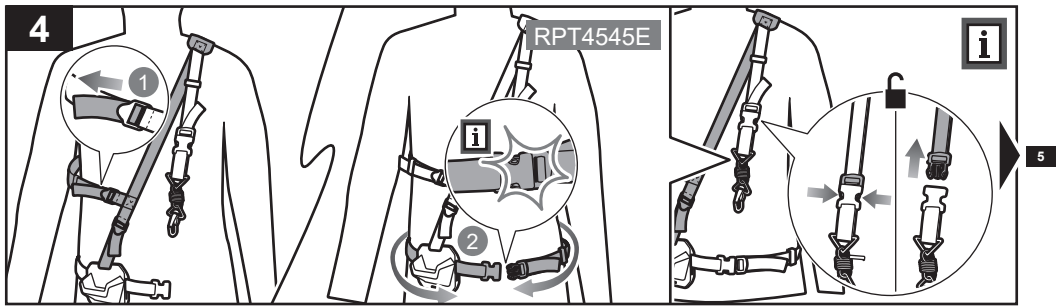
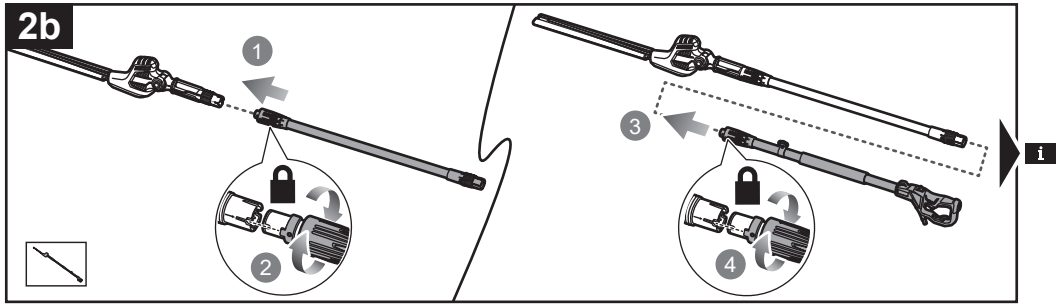

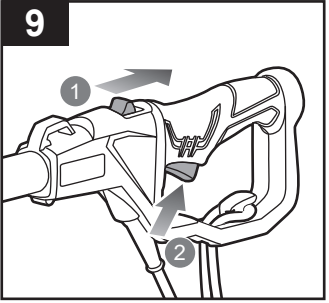
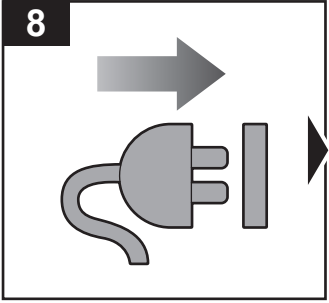
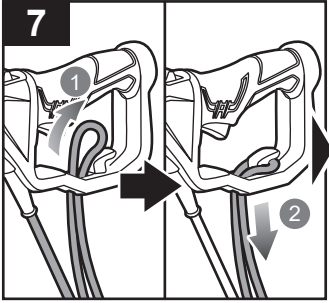



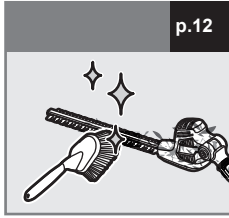
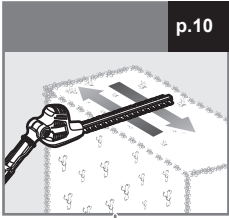

RPT4545M

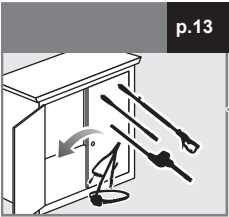
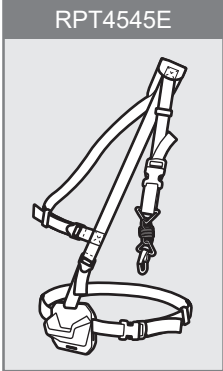
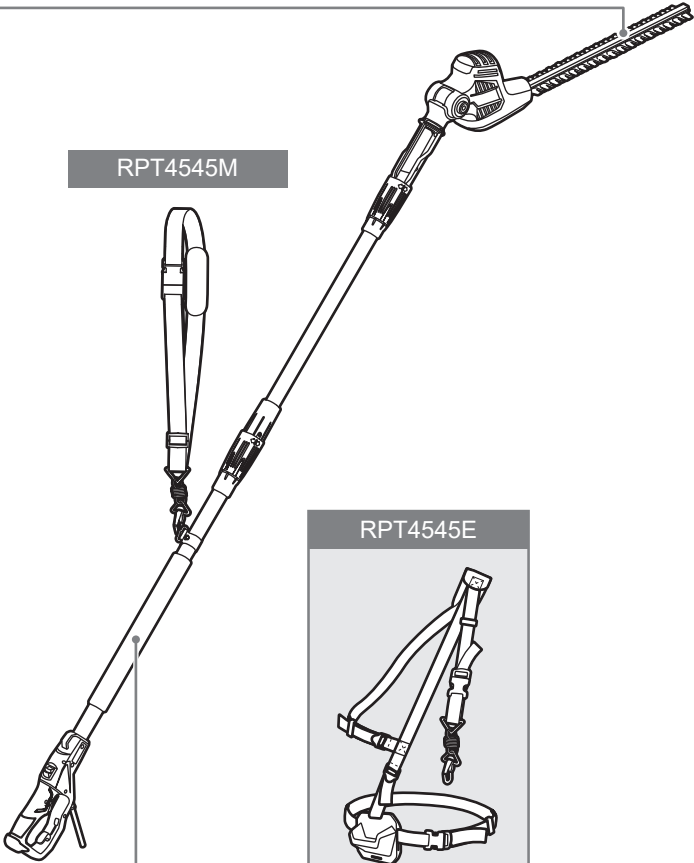

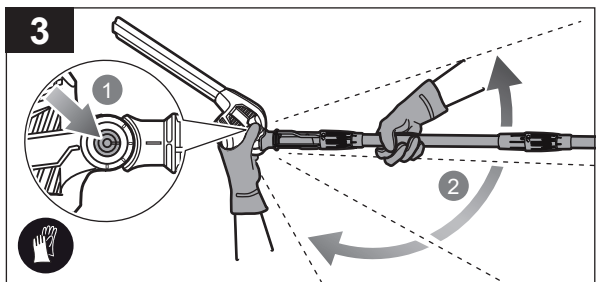
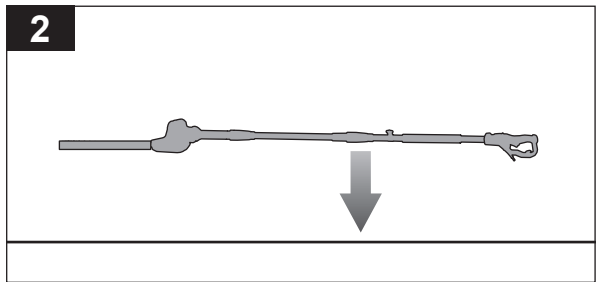
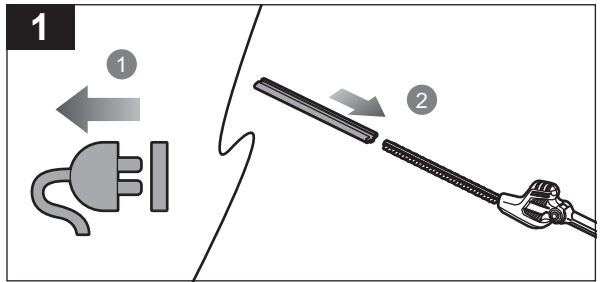
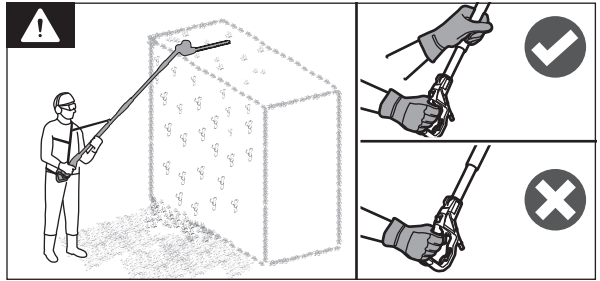
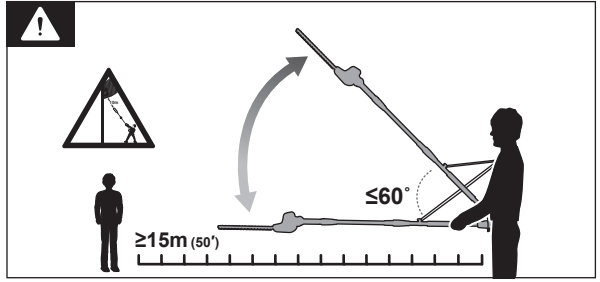
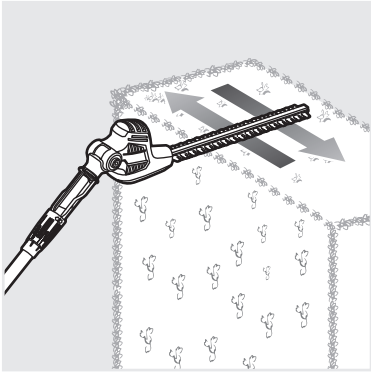

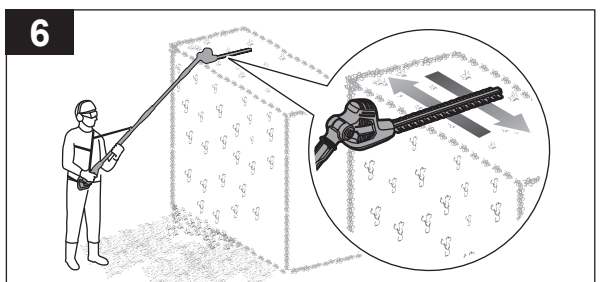
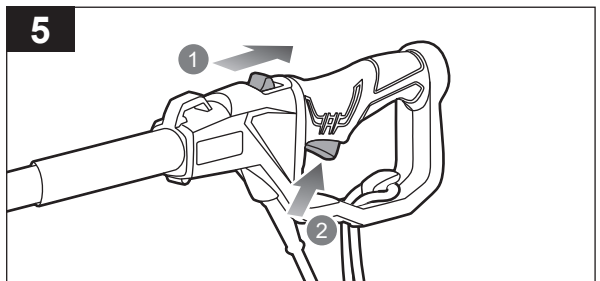
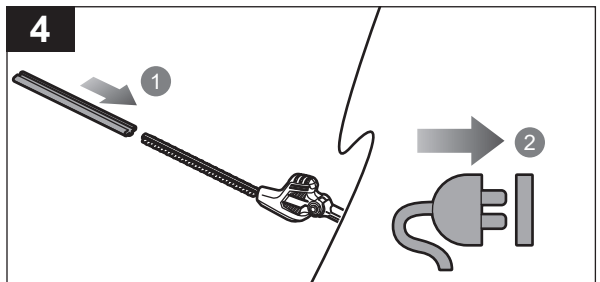
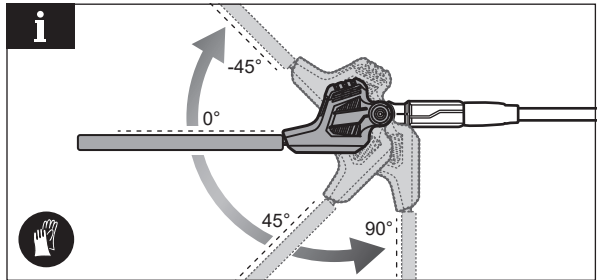
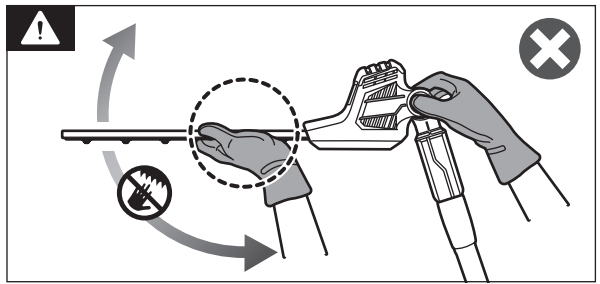

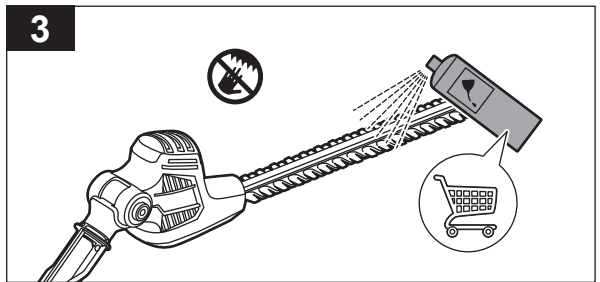
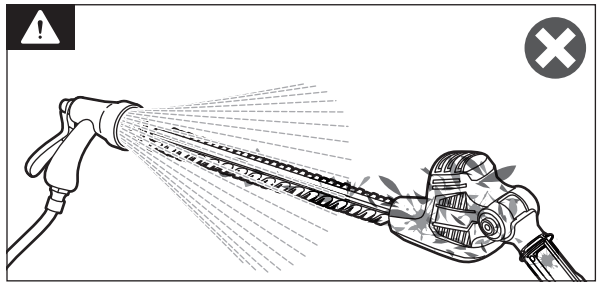
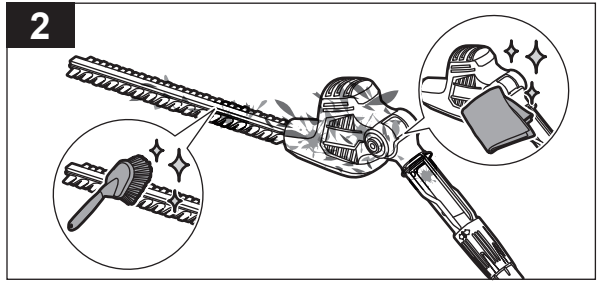
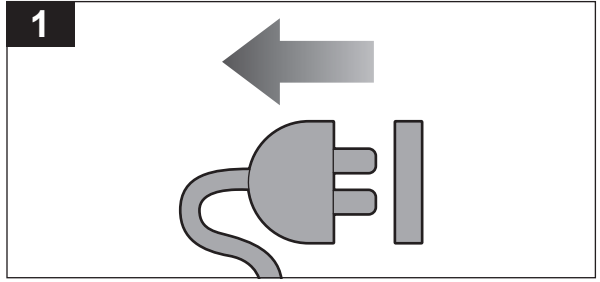
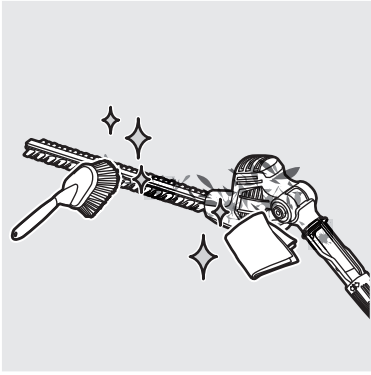

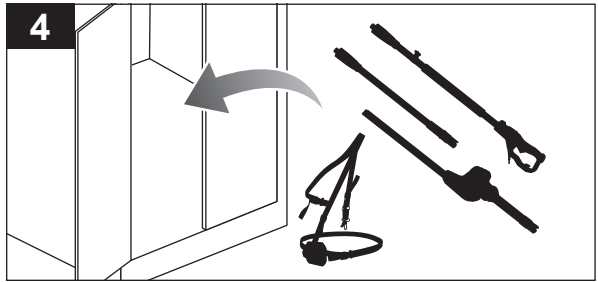
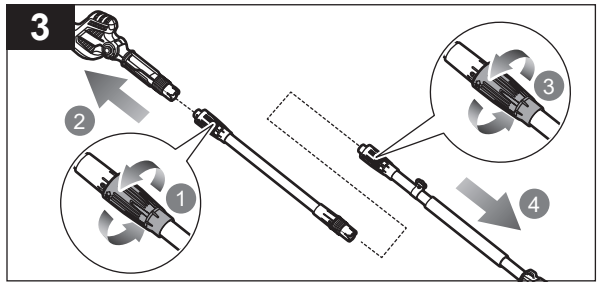
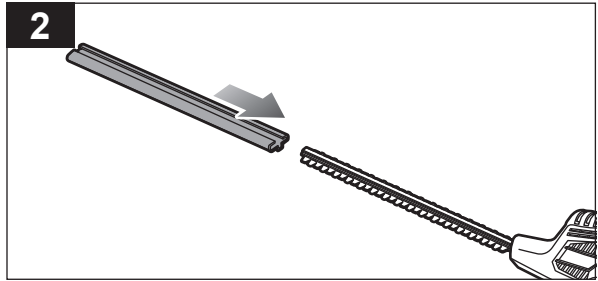
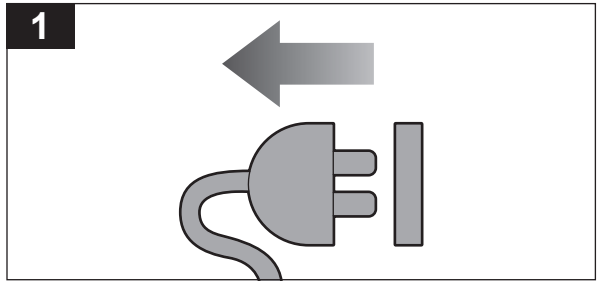

## PRODUCT SPECIFICATIONS

Electric pole hedge trimmer

Model RPT4545M / RPT4545E

Rated power 450 W

Rated voltage 220-240 V a.c. 50 Hz

No-load speed 1,700/min

Stroke rate at no load 3,400/min

Usable cutting length 450 mm

Cutting capacity 20 mm

Maximum product working length 2.6 m

Weight (without harness) 4.08 kg

Vibration level (in accordance with EN 62841-1 & EN 62841-4-2)

Front handle  $a_h = 2.61 \text{ m/s}^2$

Rear handle  $a_h = 2.71 \text{ m/s}^2$

Uncertainty of measurement  $K = 1.5 \text{ m/s}^2$

Noise emission level (in accordance with EN 62841-1 & EN 62841-4-2)

A-weighted sound pressure level at the operator's position  $L_{pA} = 85.6 \text{ dB (A)}$

Uncertainty of measurement  $K = 3.0 \text{ dB}$

A-weighted sound power level  $L_{WA} = 94.65 \text{ dB (A)}$

Uncertainty of measurement  $K = 0.81 \text{ dB}$

**NOTE:** Visit your local special orders desk or contact RYOBI customer service for replacement parts.

**⚠ WARNING!** The declared vibration total values and the declared noise emission values given in this instruction manual have been measured in accordance with a standardised test and may be used to compare one tool with another. They may be used for a preliminary assessment of exposure.

The declared vibration and noise emission values represent the main applications of the tool. However, if the tool is used for different applications, used with different accessories, or poorly maintained, the vibration and noise emission may differ. These conditions may significantly increase the exposure levels over the total working period. An estimation of the level of exposure to vibration and noise should take into account the times when the tool is turned off or when it is running idle. These conditions may significantly reduce the exposure level over the total working period.

Identify additional safety measures to protect the operator from the effects of vibration and noise, such as maintaining the tool and the accessories, keeping the hands warm (in case of vibration), and organising work patterns.

## RYOBI WARRANTY APPLICATION CONDITIONS

In addition to any statutory rights resulting from the purchase, this product is covered by a warranty as stated below.

- The warranty period is 24 months for consumers and commences on the date when the product was purchased. This date has to be documented by an invoice or other proof of purchase. The product is designed and dedicated to consumer and private use only. So there is no warranty provided in case of professional or commercial use. This warranty applies only on new products.
- There is a possibility to extend for a part of the range of power tools (AC/DC) the warranty period over the period described above using the registration on the [www.ryobitools.eu](http://www.ryobitools.eu) website. The eligibility of products for extended warranty is clearly displayed in stores and / or on packaging and is contained within the product documentation. The end user is required to register his/her newly-acquired products online within 30 days from the date of purchase. The end user may register for the extended warranty in his/her country of residence if listed on the online registration form where this option is valid. Furthermore, end users must give their consent to the storage of their personal data that is required to be entered online. They must also accept the terms and conditions. The registration confirmation receipt, which is sent out by e-mail, and the original invoice showing the date of purchase will serve as proof of the extended warranty.
- The warranty covers all defects of the product during the warranty period due to faults in workmanship or material at the purchase date. The warranty is limited to repair and/or replacement and does not include any other obligations including but not limited to incidental or consequential damages. The warranty is not valid if the product has been misused, used contrary to the instruction manual, or has been incorrectly connected to a power supply. This warranty does not apply to:
  - any damage to the product that is the result of improper or lack of maintenance
  - any product that has been altered or modified
  - any product where original identification (trade mark, serial number) markings have been defaced, altered or removed
  - any damage caused by non-observance of the instruction manual
  - any product not displaying the CE approval mark on the rating plate
  - any product that has been attempted to be repaired by a non-authorized warranty service centre or without prior authorisation by Technronic Industries
  - any product connected to improper power supply (amps, voltage, frequency)
  - any product used with inappropriate fuel mixture (fuel, oil, ratio of oil/ fuel mixture)
  - any damage caused by external influences (water, chemical, physical, shocks) or foreign substances
  - normal wear and tear spare parts
  - inappropriate use, overloading of the tool
  - use of non-approved accessories or parts
  - Accessories provided with the tool or purchased separately including but not limited to blades, saw chains, cutting lines, etc.
  - Any periodic adjustments to or maintenance cleaning of carburetors
  - Components (parts and accessories) subject to natural wear and tear, including but not limited to bump knobs, drive belts, clutch, blades of hedge trimmers or lawn mowers, harness, cable throttle, carbon brushes, power cord, tines, felt washers, hitch pins, blower fans, blower and vacuum tubes, vacuum bag and straps, guide bars, saw chains, hoses, connector fittings, spray nozzles, wheels, spray wands, inner reels, outer spools, cutting lines, spark plugs, air filters, gas filters, mulching blades, etc.
- For servicing, the product must be sent or presented to a RYOBI authorised service station listed for each country in the following list of service station addresses. In some countries your local RYOBI dealer undertakes to send the product to the RYOBI service organisation. When sending a product to a RYOBI service station, the product should be safely packed without any dangerous contents such as petrol, marked with sender's address and accompanied by a short description of the fault.
- A repair / replacement under this warranty is free of charge. It does not constitute an extension or a new start of the warranty period. Exchanged parts or products become our property. In some countries delivery charges or postage will have to be paid by the sender. Your statutory rights arising from the purchase of the product remain unaffected.
- The warranty is valid in the European Community, Switzerland, Iceland, Norway, Liechtenstein, Turkey, Russia, and the United Kingdom. Outside these areas, please contact your authorised RYOBI dealer to determine if another warranty applies.

## AUTHORISED SERVICE CENTRE

Any request or issue with the product can be addressed to your local authorised service centres (visit [www.ryobitools.eu](http://www.ryobitools.eu)) or directly to: Technronic Industries GmbH, Max Eyth Straße 10, 71364 Winnenden, Germany. Please state the serial number and product type printed on the label.

## EC DECLARATION OF CONFORMITY

Manufacturer: Technronic Industries GmbH  
Max-Eyth-Straße 10, 71364 Winnenden, Germany

We declare as the manufacturer under our sole responsibility that the product mentioned below

Electric pole hedge trimmer

Brand: RYOBI

Model number: RPT4545E

Serial number range: 48618601000001 - 48618601999999

fulfills all the relevant provisions of the following European Directives, European Regulations and harmonised standards:

2006/42/EC, 2014/30/EU, 2000/14/EC, 2005/88/EC, 2011/65/EU,

EN 62841-1:2015+A11:2022, EN 62841-4-2:2019+A1:2022+A11:2022,

EN IEC 55014-1:2021, EN IEC 55014-2:2021,

EN IEC 61000-3-2:2019+A1:2021, EN 61000-3-3:2013+A1:2019+A2:2021,

EN IEC 63000:2018

Measured sound power level: 94.65 dB(A)

Guaranteed sound power level: 96 dB(A)

Conformity assessment method to Annex V Directive 2000/14/EC amended by 2005/88/EC.



Todd Chipner

Vice President, Quality – Asia

Winnenden, May 12, 2023

Authorised to compile the technical file:

Alexander Krug, Managing Director

Technronic Industries GmbH

Max-Eyth-Straße 10, 71364 Winnenden, Germany

## GB-DECLARATION OF CONFORMITY

Manufacturer: Technronic Industries GmbH  
Max-Eyth-Straße 10, 71364 Winnenden, Germany

We declare as the manufacturer under our sole responsibility that the product mentioned below

Electric pole hedge trimmer

Brand: RYOBI

Model number: RPT4545M

Serial number range: 48618201000001 - 48618201999999

fulfills all the relevant provisions of the following Regulations: S.I. 2008/1597 (as amended), S.I. 2016/1091 (as amended), S.I. 2012/3032 (as amended), S.I. 2001/1701 (as amended) and that the following designated standards have been used:

BS EN 62841-1:2015+A11:2022, BS EN 62841-4-2:2019+A11:2022,

BS EN IEC 55014-1:2021, BS EN IEC 55014-2:2021,

BS EN IEC 61000-3-2:2019+A1:2021, BS EN 61000-3-3:2013+A2:2021,

BS EN IEC 63000:2018

Measured sound power level: 94.65 dB(A)

Guaranteed sound power level: 96 dB(A)

Conformity assessment method to S.I. 2001/1701 Schedule 8 (as amended)



Todd Chipner

Vice President, Quality – Asia

Winnenden, May 12, 2023

Authorised to compile the technical file:

Technronic Industries (UK) Ltd

Parkway

Marlow Bucks SL7 1YL

UK



**Techtronic Industries GmbH**  
Max-Eyth-Straße 10,  
71364 Winnenden, Germany

**Techtronic Industries (UK) Ltd**  
Parkway  
Marlow Bucks SL7 1YL  
UK

099853006001-02

